

# Operating instructions for the system user

**VIESMANN**

Control unit with 3.5 inch black/white screen



## **VITODENS 200-W/222-W/222-F/242-F**



### For your safety

-  Please follow these safety instructions closely to prevent accidents and material losses.

### Safety instructions explained

-  **Danger**  
This symbol warns against the risk of injury.

**Note**  
*Details identified by the word "Note" contain additional information.*

-  **Please note**  
This symbol warns against the risk of material losses and environmental pollution.

### Target group

These operating instructions are designed for heating system users. This appliance can also be operated by children aged 8 and older, as well as by individuals with reduced physical, sensory or mental faculties or those lacking in experience and knowledge, provided such individuals are supervised or have been instructed in the safe use of this appliance and any risks arising from it.

-  **Please note**  
Supervise children in the proximity of the appliance.
- Never permit children to play with the appliance.
  - Cleaning and user maintenance must never be carried out by unsupervised children.

### Safety instructions for working on the system

#### Connecting the appliance

- The appliance may be connected and commissioned only by authorised contractors.
- Only operate the appliance with suitable fuels.
- Observe the specified electrical connection requirements.
- Modifications to the existing installation may only be carried out by authorised specialists.

-  **Danger**  
Incorrectly executed work on the heating system can lead to life threatening accidents.
- Work on gas installations may only be carried out by a registered gas fitter.
  - Work on electrical equipment may only be carried out by a qualified electrician.

**For your safety** (cont.)**Working on the appliance**

- All settings and work on the appliance must be performed as specified in these operating instructions. Further work on the appliance may be carried out only by authorised contractors.
- Do not open the appliance.
- Do not remove casings.
- Do not modify or remove attachments or fitted accessories.
- Do not open or tighten pipe connections.

**Danger**

Hot surfaces can cause burns.

- Do not open the appliance.
- Never touch the hot surfaces of uninsulated pipes, fittings or flue pipes.

**Auxiliary components, spare and wearing parts****Please note**

Components not tested with the heating system may damage the system or affect its function. Have all installation or replacement work carried out exclusively by your contractor.

**Safety instructions for operating the system****Damage to the appliance****Danger**

Damaged equipment poses a safety hazard.

Check the appliance for external damage. Never start up a damaged appliance.

**If you smell gas****Danger**

Escaping gas can lead to explosions which may result in serious injury.

- No smoking! Prevent naked flames and sparks. Never switch lights or electrical appliances on or off.
- Close the gas shut-off valve.
- Open windows and doors.
- Evacuate any people from the danger zone.
- Notify your gas and power supply utility and your local heating contractor from outside the building.
- Have the power supply to the building shut off from a safe place (outside the building).

### If you smell flue gas

-  **Danger**  
Flue gas can lead to life threatening poisoning.
- Shut down the heating system.
  - Ventilate the installation site.
  - Close all doors in the living space.

### If there is a fire

-  **Danger**  
Fire presents a risk of burns and explosion.
- Shut down the heating system.
  - Close the shut-off valves in the fuel supply lines.
  - Use a tested fire extinguisher, class ABC.

### If water escapes from the appliance

-  **Danger**  
If water escapes from the appliance there is a risk of electric shock.
- Shut down the heating system at the external isolator (e.g. fuse box, domestic distribution board).
  - Please notify your contractor.

### If the heating system develops a fault

-  **Danger**  
Fault messages indicate faults in the heating system. If faults are not rectified, they can have life threatening consequences.  
Do not acknowledge fault messages several times in quick succession. Notify contractor so the cause can be analysed and the fault rectified.

### Installation room requirements

-  **Danger**  
Sealed vents result in a lack of combustion air. This leads to incomplete combustion and the formation of life threatening carbon monoxide. Never cover or close existing vents. Do not make any subsequent modifications to the building characteristics that could affect safe operation (e.g. cable/pipework routing, cladding or partitions).

-  **Danger**  
Easily flammable liquids and materials (e.g. naphtha/petrol, solvents, cleaning agents, paints or paper) can cause deflagration and fire. Never store or use such materials in the boiler room or in direct proximity to the heating system.

- !** **Please note**  
Incorrect ambient conditions can lead to heating system damage and can put safe operation at risk.
- Maintain the permissible ambient temperatures as detailed in these operating instructions.
  - Prevent air contamination by halogenated hydrocarbons (e.g. as contained in paints, solvents or cleaning fluids) and excessive dust (e.g. through grinding/polishing work).
  - Avoid continuously high humidity levels (e.g. through continuous drying of washing).

**For your safety** (cont.)**Extractors**

The operation of appliances that extract air to the outside (cooker hoods, extractors, air conditioning units, etc.) can create negative pressure. If the boiler is operated at the same time, this can lead to a reverse flow of flue gas.

**Danger**

The simultaneous operation of the boiler and appliances that extract air to the outside can result in life threatening poisoning due to a reverse flow of flue gas.

Take suitable steps to ensure an adequate supply of combustion air. If necessary, contact your contractor.

<b>1. Liability</b>	.....	9
<b>2. Introductory information</b>	Symbols .....	10
	Terminology .....	10
	Intended use .....	10
	Product information .....	11
	Permissible ambient temperatures in the installation room .....	11
	Software licences .....	11
	Commissioning .....	12
	Your system is preset .....	12
	Energy saving tips .....	13
	Tips for greater comfort .....	13
<b>3. Operation</b>	Operating principles .....	15
	■ Status display with Lightguide .....	15
	Screen displays .....	15
	■ Standby .....	15
	■ Home screen .....	15
	On-screen buttons .....	16
	System overview .....	16
	Overview of the <b>"Main menu"</b> .....	16
	Operating program .....	17
	■ Operating programs for central heating and DHW heating .....	17
	■ Special operating programs and functions .....	18
<b>4. Time programs</b>	Procedure for setting a time program .....	19
	Time programs and time phases for central heating .....	19
	■ Setting time phases .....	19
	■ Copying the time program to other days of the week .....	20
	■ Changing time phases .....	21
	■ Deleting time phases .....	21
	Time programs and time phases for DHW heating .....	22
	■ Setting a time program for the DHW comfort function (combi boilers only) .....	22
	■ Setting the time program for the DHW circulation pump .....	22
<b>5. Central heating</b>	Heating circuit selection .....	23
	Setting room temperature for a heating circuit .....	23
	■ Setting temperature levels for central heating .....	23
	Switching central heating on or off (operating program) .....	23
	Setting the heating curve .....	24
	Temporarily adjusting the room temperature .....	24
	■ Switching on <b>"Extended heating"</b> .....	24
	■ Switching off <b>"Extended heating"</b> .....	25
	Adjusting the room temperature for longer periods at home .....	25
	■ Switching on <b>"Day(s) at home"</b>  .....	26
	■ Changing <b>"Day(s) at home"</b> .....	26
	■ Switching off <b>"Day(s) at home"</b> .....	27
	Saving energy during long periods of absence .....	27
	■ Switching on <b>"Holiday"</b> .....	27
	■ Changing <b>"Holiday"</b> .....	28
	■ Switching off <b>"Holiday"</b> .....	28
<b>6. DHW heating</b>	DHW temperature .....	29
	Switching DHW heating on or off (operating program) .....	29
	One-off DHW heating outside the time program .....	29
	■ Switching on <b>"One-off DHW heating"</b> .....	29
	■ Switching off <b>"One-off DHW heating"</b> .....	30
	Increased DHW hygiene .....	30
	■ Switching on the <b>"Hygiene program"</b> .....	30

<b>Index</b>	
	<ul style="list-style-type: none"> <li>■ Switching off the <b>"Hygiene program"</b> ..... 30</li> <li>■ Switching DHW scald protection on/off ..... 30</li> </ul>
<b>7. Further adjustments</b>	<ul style="list-style-type: none"> <li>Setting the display brightness ..... 32</li> <li>Switching the <b>"Lightguide"</b> on and off ..... 32</li> <li>Setting the <b>"Time"</b> and <b>"Date"</b> ..... 32 <ul style="list-style-type: none"> <li>■ Set time ..... 32</li> <li>■ Setting the format for the time ..... 33</li> <li>■ Set the date ..... 33</li> <li>■ Setting the format for the date ..... 33</li> </ul> </li> <li>Summer/wintertime automatic changeover ..... 34</li> <li>Setting the <b>"Language"</b> ..... 34</li> <li>Setting <b>"Units"</b> ..... 34</li> <li>Switching on wireless connection to the remote control ..... 35</li> <li>Switching internet access on or off ..... 35 <ul style="list-style-type: none"> <li>■ Establishing a WiFi connection ..... 35</li> <li>■ Switching WiFi on and off ..... 36</li> </ul> </li> <li>Restoring factory settings ..... 36</li> </ul>
<b>8. Checks</b>	<ul style="list-style-type: none"> <li>Calling up help messages ..... 37</li> <li>Checking information ..... 37 <ul style="list-style-type: none"> <li>■ Calling up the contact details for your contractor ..... 37</li> <li>■ Calling up the energy balance ..... 37</li> </ul> </li> <li>Calling up licenses for the programming unit ..... 38</li> <li>Calling up licenses for the integrated wireless module ..... 38 <ul style="list-style-type: none"> <li>■ Calling up the license information for third party components ..... 38</li> <li>■ Third party software ..... 39</li> </ul> </li> <li>Checking service messages ..... 39</li> <li>Checking fault messages ..... 40 <ul style="list-style-type: none"> <li>■ Resetting the burner after a burner fault ..... 41</li> </ul> </li> <li>Acknowledging messages ..... 41</li> <li>Checking message lists ..... 42</li> </ul>
<b>9. Emissions test mode</b>	..... 43
<b>10. Switching on and off</b>	<ul style="list-style-type: none"> <li>Switching the system off ..... 44 <ul style="list-style-type: none"> <li>■ Switching off heat generation with frost protection monitoring (<b>"Switch off"</b>) ..... 44</li> <li>■ Switching off heat generation without frost protection monitoring ..... 44</li> </ul> </li> <li>Switching system on ..... 45</li> </ul>
<b>11. What to do if...</b>	<ul style="list-style-type: none"> <li>Rooms are too cold ..... 47</li> <li>Rooms are too hot ..... 48</li> <li>There is no hot water ..... 48</li> <li>The DHW is too hot ..... 49</li> <li><b>"Burner fault"</b> is displayed ..... 49</li> <li><b>"Active messages"</b> is displayed ..... 49</li> <li><b>"External hook-up"</b> is displayed ..... 49</li> <li><b>"Trade fair mode"</b> is displayed ..... 49</li> </ul>
<b>12. Maintenance</b>	<ul style="list-style-type: none"> <li>Cleaning ..... 50</li> <li>Inspection and maintenance ..... 50 <ul style="list-style-type: none"> <li>■ Appliance ..... 50</li> <li>■ DHW cylinder ..... 50</li> <li>■ Safety valve (DHW cylinder) ..... 50</li> <li>■ Potable water filter (if installed) ..... 50</li> </ul> </li> <li>Damaged cables / lines ..... 51</li> </ul>
<b>13. Appendix</b>	<ul style="list-style-type: none"> <li>System overview menu ..... 52</li> <li>Overview of main menu ..... 53</li> <li>Terminology ..... 58</li> </ul>

■ Standby mode .....	58
■ Setback mode (reduced heating mode) .....	58
■ System version .....	58
■ Operating program .....	59
■ Operating status .....	59
■ Operating mode .....	59
■ Mixer extension kit .....	59
■ Screed drying .....	59
■ Underfloor heating .....	59
■ Heating mode .....	59
■ Heating curve .....	60
■ Heating circuit .....	62
■ Heating circuit pump .....	62
■ Mixer .....	62
■ Night setback .....	62
■ Open flue operation .....	62
■ Room sealed operation .....	62
■ Room temperature .....	62
■ Return temperature .....	62
■ Safety valve .....	63
■ Solar circuit pump .....	63
■ Set temperature .....	63
■ Summer mode .....	63
■ Cylinder primary pump .....	63
■ Temperature level .....	63
■ Set temperature .....	63
■ Drinking water filter .....	63
■ Flow temperature .....	63
■ Weather-compensated operation .....	64
■ Time program .....	64
■ DHW circulation pump .....	64
Information on disposal .....	64
■ Disposal of packaging .....	64
■ Final decommissioning and disposal of the heating system .....	64
<b>14. Keyword index</b> .....	<b>65</b>



## Liability

No liability is accepted for loss of profit, unattained savings, or other direct or indirect consequential losses resulting from use of the WiFi interface integrated into the system or the corresponding internet services. No liability is accepted for losses resulting from inappropriate use.









Liability is limited to typical damage arising if a fundamental contractual obligation is violated through slight negligence, the fulfilment of which is essential for proper execution of the contract.

The limitation of liability shall not apply if the damage was caused deliberately or through gross negligence, or if mandatory liability applies due to product liability legislation.

The Viessmann General Terms and Conditions apply, which are included in each current Viessmann pricelist. The relevant data protection regulations and terms of use apply to the use of Viessmann apps. Viessmann accepts no liability for push notifications and email services, which are provided by network operators. The terms and conditions of the respective network operators therefore apply.

## Introductory information

### Symbols

Symbol	Meaning
	Reference to other document containing further information
	Step in a diagram: The numbers correspond to the order in which the steps are carried out.
	Warning of material losses and environmental pollution
	Live electrical area
	Pay particular attention.
	<ul style="list-style-type: none"><li>▪ Component must audibly click into place. or</li><li>▪ Acoustic signal</li></ul>
	<ul style="list-style-type: none"><li>▪ Fit new component. or</li><li>▪ In conjunction with a tool: Clean the surface.</li></ul>
	Dispose of component correctly.
	Dispose of component at a suitable collection point. Do <b>not</b> dispose of component in domestic waste.

### Terminology

To provide you with a better understanding of the functions of your control unit, some terminology is explained. This information can be found in chapter "Terminology" in the Appendix.

### Intended use

The appliance is intended solely for installation and operation in sealed unvented heating systems that comply with EN 12828, with due attention paid to CECS 215-2017 and the associated installation, service and operating instructions. It is only designed for heating up heating water that is of potable water quality.

Intended use presupposes that a fixed installation in conjunction with permissible, system-specific components has been carried out.

The appliance is intended exclusively for domestic or semi-domestic use; even users who have not had any instruction are able to operate the appliance safely.

**Intended use** (cont.)

Commercial or industrial usage for a purpose other than heating the building or DHW shall be deemed inappropriate.

Any usage beyond this must be approved by the manufacturer in each individual case.

Incorrect usage or operation of the appliance (e.g. the appliance being opened by the system user) is prohibited and will result in an exclusion of liability. Incorrect usage also occurs if the components in the heating system are modified from their intended use (e.g. if the flue gas and ventilation air paths are sealed).

**Product information**

The control unit is a boiler and heating circuit control unit for the following operating modes:

- Weather-compensated operation
- Continuous operation
- Room temperature-dependent operation

Your heating contractor will configure the operating mode during commissioning in accordance with your heating system. These instructions describe all 3 operating modes.

**Weather-compensated operation**

In weather-compensated operation, the flow temperature level is controlled according to the outside temperature. The lower the outside temperature, the higher the flow temperature. This means that more heat is provided for central heating on cold days than on warmer days.

In weather-compensated operation, 1 heating circuit without mixer and up to 2 heating circuits with mixer can be operated with the control unit.

**Continuous operation**

In continuous operation the heat generator provides heating water with a constant flow temperature regardless of the outside temperature.

In continuous operation, 1 heating circuit without mixer and up to 2 heating circuits with mixer can be operated with the control unit.

**Room temperature-dependent operation**

In room temperature-dependent operation, the central heating is switched on or off subject to the room temperature. The flow temperature remains constant. In room temperature-dependent operation, 1 heating circuit without mixer can be operated with the control unit.

**Operation**

The control unit is integrated into the heat generator and controls all functions of your system. The control unit is operated via a 3.5 inch black/white screen. A communication module is integrated in the control unit. This means the system can also be operated remotely via the internet with an app. Some functions can be controlled via a remote control in weather-compensated operation or via a room temperature controller in room temperature-dependent operation.

**Permissible ambient temperatures in the installation room**

- !** **Please note**  
The appliance may develop faults if it is operated outside the specified temperature ranges. Ensure that the specified temperature range is maintained in the installation room.

To prevent malfunctions, ensure that the room is free from the risk of frost, dry and heated.

**Software licences**

This product contains third party software, including open source software. You are authorised to use this third party software subject to compliance with the relevant licensing terms.

- Licences for the communication module: See page 38.
- Licences for the programming unit: See page 38.

### Commissioning

The commissioning and matching of the appliance to local conditions and building characteristics, as well as instructing the user in the operation of the system, must be carried out by your contractor.

As the user of new combustion equipment, you may be obliged to notify your local flue gas inspector of the installation [check local regulations]. Your local flue gas inspector will also inform you [where appropriate] about work that may have to be carried out on your combustion equipment (such as regular checks, cleaning).

### Your system is preset

Your heating system is preset at the factory and is therefore ready for operation following commissioning by your contractor:

#### Central heating in weather-compensated operation

- Between **06:00 h and 22:00 h**, rooms are heated to 20 °C ("**Standard**" temperature level).
- Between **22:00 h and 06:00 h**, rooms are heated to 3 °C ("**Reduced**" temperature level, frost protection).

#### Central heating in continuous operation

- Between **06:00 h and 22:00 h**, the set flow temperature is 60 °C ("**Standard**" temperature level)
- Between **22:00 and 06:00** the set flow temperature is 20 °C ("**Reduced**" temperature level, frost protection)

#### Central heating in room temperature-dependent operation

- The rooms are heated in accordance with the settings on your room temperature controller.

#### DHW heating

- Between **05:30 and 22:00 h**, the DHW is heated to 50 °C ("**Standard**" temperature level). Any installed DHW circulation pump is switched on.
- Between **22:00 and 05:30 h**, the DHW cylinder is not reheated. Any installed DHW circulation pump is switched off.

#### Note

*Any DHW heating started before **22:00 h** remains on until the set DHW temperature has been reached.*

#### Frost protection

- Your heat generator and DHW cylinder (if installed) are protected against frost.

#### Wintertime/summertime changeover

- This changeover is automatic.

#### Date and time

- The date and time were set by your heating contractor.

You can change the settings at any time to suit your individual requirements.

#### Power failure

*All settings are retained if there is a power failure.*

## Energy saving tips

### Saving energy when using central heating

- Do not overheat your home. Every degree of room temperature reduction saves up to 6 % on your heating bills.  
Weather-compensated operation and room temperature-dependent operation:  
Do not set your standard room temperature ("**Standard**" temperature level) to above 20 °C: See page 23.
- Heat your home to the reduced temperature at night or during regular absences:
  - Weather-compensated operation:  
Reduced room temperature
  - Continuous operation and room temperature-dependent operation:  
Reduced flow temperature
 For this, adjust the settings in the time program for central heating ("**Time programs**" "**Heating**"): See page 19.  
In room temperature-dependent operation, time programs for central heating can only be set at the room temperature controller.



Operating instructions, room temperature controller

- To switch off functions that are not required (e.g. central heating in summer), set operating program to "**OFF**" for the relevant heating circuits: See page 23.
- If you are going away, set the "**Holiday**" function: See page 27.  
During the period that you are away, the room temperature will be reduced and DHW heating switched off.  
**Note**  
*This function is not adjustable in room temperature-dependent operation.*

### Saving energy on DHW heating

- At night or during regular absences, heat the DHW to a lower temperature. To do so, adjust the time program for DHW heating: See page 22.
- Switch on DHW circulation only for those times in which you regularly use hot water. For this, adjust the time program for the DHW circulation pump: See page 22.

For additional energy saving functions, please contact your contractor.

## Tips for greater comfort

### More comfort in your home

- Set your individual preferred temperature: See page 23.
- Adjust the time program for your heating circuits so that your individual preferred temperature is automatically reached when you are present: See page 19.  
In room temperature-dependent operation, time programs for central heating can only be set at the room temperature controller.
- Only for weather-compensated operation:  
Adjust the heating curves so that your home is heated to your individual preferred temperature all year round: See page 24.
- If you need a higher room temperature in the short term, select the "**Extended heating**" function: See page 24.  
Example: Late in the evening, the reduced room temperature is set by the time program. Your guests stay longer.  
**Note**  
*This function is not adjustable in room temperature-dependent operation.*
- If you are spending more time than usual in your home, select the "**Day(s) at home**" function: See page 25.  
E.g. for public holidays or when the children are on school holidays.  
**Note**  
*This function is not adjustable in room temperature-dependent operation.*

#### Sufficient DHW heating for your needs

- Adjust the time program for DHW heating so that there is always sufficient hot water in accordance with your habitual routines: See page 22.  
Example: You need more DHW in the morning than in the daytime.
- Only for weather-compensated or continuous operation:  
Adjust the time program for the DHW circulation pump so that DHW is available immediately from the taps during periods when hot water is drawn more frequently: See page 22.
- If you need your DHW at a higher temperature for a short while, select **"One-off DHW heating"**: See page 29.

## Operating principles

### Display

You can adjust any setting on your system centrally at the control unit.

The control unit is equipped with a black/white screen. To input settings and check information, tap the on-screen buttons.

### Remote control for weather-compensated operation

If remote control units are installed in your rooms, you can also adjust the settings at the remote control units.



Remote control operating instructions

### Room temperature controller for room temperature-dependent operation

If a room temperature controller is installed in one of your rooms, you can adjust some settings at the room temperature controller.



Operating instructions, room temperature controller

## Status display with Lightguide

Depending on the type of heat generator, a red illuminated strip (Lightguide) is displayed at the lower or upper edge of the control unit during operation.

Meaning of the display:

- Lightguide pulsates slowly:  
Display is in standby mode.
- Lightguide is illuminated constantly:  
You are operating the control unit. Every input operation is confirmed by a brief flashing.
- Lightguide flashes quickly:  
There is a fault on the system.

### Note

You can switch off the Lightguide. See page 32.

## Screen displays

### Standby

The display backlighting is switched off after approx. 2 minutes.

### Home screen

After starting or activating the control unit, the home screen is shown.

The home screen shows information on "**Heating circuit 1**".

Call up the home screen as follows:

- Standby is enabled:  
Tap any on-screen button.
- From anywhere in the menu:  
Tap repeatedly until the home screen is shown.

### Note

If your contractor has set up your heat generator to provide only DHW heating or to operate in weather-compensated mode with a room temperature controller, the information for "**DHW**" will be shown.

## On-screen buttons

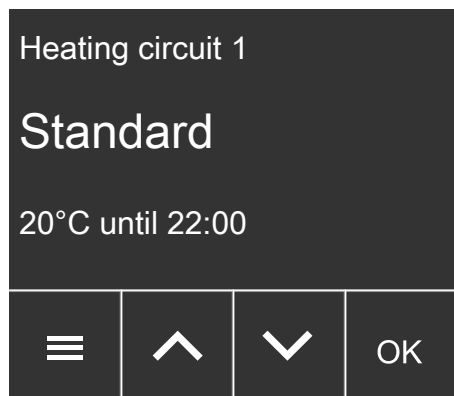









Fig. 1

-  ■ Calls up the main menu.
-  ■ Takes you one step back.
-  To select a menu or adjust values.
-  Confirms your selection or saves the setting made.

Special key combinations:

- Direct to system overview from a menu:  
 should be pressed for approx. 4 s.
- Establishing internet connection:  
 In the home screen, press and hold **OK** for approx. 4 s.
- Switching WiFi on and off:  
 + **OK** should be pressed simultaneously for approx. 4 s.
- Calling up burner status:  
 +  should be pressed simultaneously for approx. 4 s.

## System overview

Depending on the system equipment level, you can check the most important information in the system overview:

- Heating circuit 1 (home screen), not for "weather-compensated mode with room temperature controller"
- Only for weather-compensated or continuous operation:  
 Additional heating circuits
- Solar
- DHW
- WiFi
- System pressure

**Tap the following on-screen buttons:**

1. Call up the home screen.
2.  for the required information

Calling up further information: See page 37.

### Note

*If names have been given to the heating circuits, the allocated name is shown.*

## Overview of the "Main menu"



In the main menu, you can check and adjust all of the settings for the appliance's range of functions. You can find the menu overview on page 53.

Available menus:

- Trade fair mode (if set by your contractor – heating, DHW and frost protection are not active)
- Active messages (if there are any current messages)
- Quick options
- Temperature levels
- Turn on/off
- WiFi
- Time programs
- Consumption
- Solar yield

- Information
- Settings
- For your flue gas inspector only:  
 Test mode

**Tap the following on-screen buttons:**

1. Call up the home screen.
2. 
3.  for the required menu
4. **OK** to confirm



## Operating program

### Operating programs for central heating and DHW heating

#### Note

The operating programs for central heating and DHW heating can be set separately or all together for the entire system.

Operating program	Function
<b>Central heating</b>	
"Heating circuit" "ON"	<p>The rooms of the selected heating circuit are heated in accordance with the specified room temperature or flow temperature and the time program (see chapter "Central heating").</p> <p><b>Note</b> In room temperature-dependent operation, the time program for central heating can only be set at the room temperature controller: See the operating instructions for the room temperature controller.</p>
"Heating circuit" "OFF"	<ul style="list-style-type: none"> <li>▪ No central heating</li> <li>▪ Frost protection for the heat generator is enabled.</li> </ul>
<b>DHW heating</b>	
"DHW" "ON"	DHW is heated in accordance with the DHW temperature and time program specified (see chapter "DHW heating").
"DHW" "OFF"	<ul style="list-style-type: none"> <li>▪ No DHW heating</li> <li>▪ Frost protection for the DHW cylinder is enabled.</li> </ul>
<b>System</b>	
"Entire system" "ON"	<ul style="list-style-type: none"> <li>▪ Your home is heated in accordance with the specified room temperature or flow temperature and the time program (see chapter "Central heating").</li> </ul> <p><b>Note</b> In room temperature-dependent operation, the time program for central heating can only be set at the room temperature controller: See the operating instructions for the room temperature controller.</p> <ul style="list-style-type: none"> <li>▪ DHW is heated in accordance with the DHW temperature and time program specified (see chapter "DHW heating").</li> </ul>
"Entire system" "OFF"	<ul style="list-style-type: none"> <li>▪ No central heating</li> <li>▪ No DHW heating</li> <li>▪ Frost protection for the heat generator and the DHW cylinder is enabled.</li> </ul>

#### Special operating programs and functions

##### ■ "Screed drying"

This function is switched on by your contractor. Your screed is dried in line with a set time program (temperature/time profile) suitable for the relevant building materials. Your settings for central heating have no effect on the duration of screed drying (max. 32 days). The system no longer provides DHW heating. The **"Screed drying"** function can be altered or switched off by your contractor.

##### ■ "External hook-up"

The operating program set at the control unit was changed over by an external device, e.g. an EM-EA1 extension (DIO electronics module). The operating program cannot be changed via the control unit for as long as the external hook-up is enabled.

- Only for weather-compensated operation and continuous operation:

**"Holiday"**: See page 27.

- Only for weather-compensated operation and continuous operation:

**"Day(s) at home"**: See page 25.

##### **Note**

*In the system overview you can call up the active operating program: See page 16.*

## Procedure for setting a time program

The following explains how to enter the settings for a time program. The specifics of the individual time programs can be found in the relevant chapters. The time programs can be set **individually** to be the same, or different, for every day of the week.

In the time programs, you specify what your heating system should do at what time. To do so, divide the day into sections. These are called **time phases**. Different temperature levels are enabled within and outside these time phases.

You can set up a time program for the following functions:

Function	Temperature level	
	Within the time phase	Outside the time phase
Central heating	Weather-compensated operation: Your rooms are heated to standard room temperature or comfort room temperature.	Your rooms are heated to reduced room temperature.
	Continuous operation: Your rooms are heated with standard flow temperature or comfort flow temperature.	Your rooms are heated with reduced flow temperature.
	Room temperature-dependent operation: A time program for central heating can only be set at the room temperature controller.  Operating instructions, room temperature controller	
DHW heating	DHW heating is switched on. The water in the DHW cylinder is heated to the set DHW temperature.	DHW heating is switched off.
DHW circulation pump	The DHW circulation pump is switched on.	The DHW circulation pump is switched off.

## Time programs and time phases for central heating

### Note

In room temperature-dependent operation, the time program for central heating can only be set at the room temperature controller: See the operating instructions for the room temperature controller.

Factory settings: **One** time phase from 06:00 to 22:00 h for every day of the week

### Setting time phases







You can set up to 4 time phases in each time program. For each time phase, you define a start and end point.

#### Example:













Time program for **"Monday"** for **"Heating circuit 1"**

- Time phase 1:  
06:30 to 12:00 h with standard room temperature
  - Time phase 2:  
15:00 to 21:00 h with comfort room temperature
- In between these time phases the system heats to a reduced temperature.

Tap the following on-screen buttons:

1. Call up the home screen.
2. 
3.  for **"Time programs"**
4. **OK** to confirm
5.  for **"Heating"**
6. **OK** to confirm
7.  for **"Heating circuit 1"** (required heating circuit, if several heating circuits are installed)
8. **OK** to confirm
9.  for **"Monday"** (required day of the week)
10. **OK** to confirm
11.  for the time phase **"06:00 - 22:00"** (required time phase that needs to be changed)
12. **OK** to confirm

### Time programs and time phases for central... (cont.)

13.  for "Edit"
14. **OK** to confirm
15.  for the start time "06" (hours)
16. **OK** to confirm
17.  for the start time "30" (minutes)
18. **OK** to confirm
19.  for the end time "12" (hours)
20. **OK** to confirm
21.  for the end time "00" (minutes)
22. **OK** to confirm
23.  for "Standard" (temperature level)
24. **OK** twice to confirm
25.  for "Add" (further time phase)
26. **OK** to confirm
27.  for the start time "15" (hours)
28. **OK** to confirm
29.  for the start time "00" (minutes)
30. **OK** to confirm
31.  for the end time "21" (hours)
32. **OK** to confirm
33.  for the end time "00" (minutes)
34. **OK** to confirm
35.  for "Comfort" (temperature level)
36. **OK** twice to confirm
37.  for approx. 4 s to exit the menu.

#### Note











*When adjusting the setting, bear in mind that your system requires some time to heat the rooms to the required temperature.*

### Copying the time program to other days of the week

#### Example:

You want to copy the time program for "Monday" over to "Thursday" and "Friday".

#### Tap the following on-screen buttons:

1. Call up the home screen.
2. 
3.  for "Time programs"
4. **OK** to confirm
5.  for "Heating"
6. **OK** to confirm
7.  for "Heating circuit 1" (required heating circuit, if several heating circuits are installed)
8. **OK** to confirm
9.  for "Monday" (required day from which the time program is to be copied)
10. **OK** to confirm
11.  for "Copy"
12. **OK** to confirm
13.  for "Thursday" (required days to which the time program is to be applied)
14. Place a tick next to Thursday with **OK**.
15.  for "Friday" (required days to which the time program is to be applied)
16. Place a tick next to Friday with **OK**.
17.  for "Copy to"
18. **OK** to confirm
19. **OK** to acknowledge the information
20.  for approx. 4 s to exit the menu.

## Time programs and time phases for central... (cont.)

Additional time programs can be copied and applied correspondingly:









- Time programs for a heating circuit can be simultaneously transferred to another heating circuit. To do so, copy **"Heating circuit 1"** instead of the day of the week (in the Monday example).
- You can simultaneously transfer time programs for DHW heating to the DHW circulation pump or vice versa. Copy **"DHW"** or **"DHW circulation pump"** for this.

### Changing time phases

#### Example:

For **"Monday"**, you want to change the end time for time phase 2 to 19:00 h.

#### Tap the following on-screen buttons:









1. Call up the home screen.
2. 
3.  for **"Time programs"**
4. **OK** to confirm
5.  for **"Heating"**
6. **OK** to confirm
7.  for **"Heating circuit 1"** (required heating circuit, if several heating circuits are installed)
8. **OK** to confirm
9.  for **"Monday"** (required day of the week)
10. **OK** to confirm
11.  for the time phase **"15:00 - 21:00"** (required time phase that needs to be changed)
12. **OK** to confirm
13.  for **"Edit"**
14. **OK** to confirm
15. **OK** twice to confirm the unchanged start time (hour and minutes)
16.  for the end time **"19"** (hours)
17. **OK** to confirm the new end time (hour)
18. **OK** twice to confirm the unchanged entries for end time (minutes) and temperature level
19. **OK** to acknowledge the information
20.  for approx. 4 s to exit the menu

### Deleting time phases

#### Example:

For **"Monday"**, you want to delete time phase 2.

#### Tap the following on-screen buttons:

1. Call up the home screen.
2. 
3.  for **"Time programs"**
4. **OK** to confirm
5.  for **"Heating"**
6. **OK** to confirm
7.  for **"Heating circuit 1"** (required heating circuit, if several heating circuits are installed)
8. **OK** to confirm
9.  for **"Monday"** (required day of the week)
10. **OK** to confirm
11.  for the time phase **"15:00 - 19:00"** (required time phase that needs to be deleted)
12. **OK** to confirm
13.  for **"Delete"**
14. **OK** to confirm
15. **OK** to acknowledge the information
16.  for approx. 4 s to exit the menu

### Time programs and time phases for DHW heating

Factory settings: 05:30 to 22:00 h

You can change the time program **individually** in accordance with your requirements.

Tap the following on-screen buttons:

1. Call up the home screen.

2. 

3.  for "Time programs"

4. OK to confirm

5.  for "DHW"

6. OK to confirm

7.  for "DHW"

8. OK to confirm

9. For other procedures, e.g. to set time phases, see page 19.

#### Note

- The DHW is not heated between the time phases. Frost protection for the DHW cylinder is enabled.
- When setting time programs, bear in mind that your system requires some time to heat the DHW cylinder to the required temperature.

### Setting a time program for the DHW comfort function (combi boilers only)

Factory settings: 05:30 to 22:00 h

#### Note

With a "Combi boiler", the "DHW comfort function" is active during the set time phases (plate heat exchanger is kept up to temperature).

The time phases need to be deleted to switch off the comfort function.

You can change the time program for the comfort function **individually** in accordance with your requirements.

Tap the following on-screen buttons:

1. Call up the home screen.

2. 

3.  for "Time programs"

4. OK to confirm

5.  for "DHW"

6. OK to confirm

7.  for "DHW"

8. OK to confirm

9. To continue: See page 19.

### Setting the time program for the DHW circulation pump

You can change the time program **individually** in accordance with your requirements.

Tap the following on-screen buttons:

1. Call up the home screen.

2. 

3.  for "Time programs"

4. OK to confirm

5.  for "DHW"

6. OK to confirm

7.  for "DHW circulation pump"

8. OK to confirm

9. To continue: See page 19.

#### Note

Between the time phases the DHW circulation pump remains off.

## Heating circuit selection

### Note

*In room temperature-dependent operation, only one heating circuit can be operated with the control unit. For this reason, heating circuit selection is not available.*

The heating of your rooms can be split over several heating circuits if required. E.g., one heating circuit for your home, and one heating circuit for your office. The heating circuits are designated "**Heating circuit 1**", "**Heating circuit 2**" etc. at the factory. Your contractor can rename your heating circuits for you.

If names have been given to the heating circuits, the allocated name is shown in the menus.

- If you are operating several heating circuits, some adjustments will require you to first select the heating circuit to which the change should apply.
- If you are only operating one heating circuit, this option is not available.

## Setting room temperature for a heating circuit

### Factory settings for the temperature levels

Weather-compensated operation:

- Standard room temperature: 20 °C
- Reduced room temperature: 3 °C
- Comfort room temperature: 20 °C

Continuous operation and room temperature-dependent operation:

- Standard flow temperature: 60 °C
- Reduced flow temperature: 20 °C
- Only for continuous operation  
Comfort flow temperature: 70 °C

### Continuous operation and room temperature-dependent operation







*Only change the set values for the flow temperature if the heat supply for central heating is insufficient.*

## Setting temperature levels for central heating

### Note

*With room temperature-dependent operation, enter the set room temperature at your room temperature controller.*

### Tap the following on-screen buttons:

1. Call up the home screen.
2. 
3.  for "**Temperature levels**"
4. **OK** to confirm
5. Use  to select the required heating circuit.
6. **OK** to confirm
7.  for the required temperature level: "**Standard**", "**Reduced**" or "**Comfort**"
8. **OK** to confirm
9.  for the required temperature
10. **OK** to confirm
11. **OK** to acknowledge the information
12.  for approx. 4 s to exit the menu.

## Switching central heating on or off (operating program)







For information on the operating programs, see page 17.

### Tap the following on-screen buttons:

1. Call up the home screen.
2. 
3.  for "**Turn on/off**"
4. **OK** to confirm

## Central heating

### Switching central heating on or off (operating... (cont.))

5.   for "Heating" or "Entire system"
6. **OK** to confirm
7. If "Heating" was selected, use   as applicable for the required heating circuit
8. **OK** to confirm
9.   for "ON" or "OFF"
10. **OK** to confirm
11.  for approx. 4 s to exit the menu.













### Setting the heating curve

The heating curve can only be adjusted in weather-compensated operation.  
By setting the "Heating curve", you influence the flow temperature provided by the heat generator.  
So that your rooms are heated optimally at all outside temperatures, you can adjust "Heating curve" "Slope" and "Level".

Factory settings:

- "Slope": 1.4
- "Level": 0

Tap the following on-screen buttons:

1. Call up the home screen.
2. 
3.   for "Settings"
4. **OK** to confirm
5.   for "Heating curve"
6. **OK** to confirm
7. Use   to select the required heating circuit.
8. **OK** to confirm
9.   for "Slope" or "Level"
10. **OK** to confirm
11.   for the selected value
12. **OK** to confirm
13. **OK** to acknowledge the information
14.  for approx. 4 s to exit the menu.

### Temporarily adjusting the room temperature

#### Note







Only for weather-compensated or continuous operation.

Switch on the "Extended heating" function if you want to heat your home with **standard room temperature/flow temperature** or **comfort room temperature/flow temperature** during a time phase with reduced room temperature.

Your home will be heated with the temperature of the last active time phase for standard room temperature/flow temperature or comfort room temperature/flow temperature.

### Switching on "Extended heating"

Tap the following on-screen buttons:

1. Call up the home screen.
2. 
3.   for "Quick options"
4. **OK** to confirm
5.   for "Extended heating"
6. **OK** to confirm
7. Use   as applicable for the required heating circuit or "All heating circuits"
8. **OK** to confirm



## Temporarily adjusting the room temperature (cont.)

9. **OK** to switch the function on.
10. **OK** to acknowledge the information
11. **≡** for approx. 4 s to exit the menu.

### Switching off "Extended heating"

Tap the following on-screen buttons:

1. Call up the home screen.
2. **≡**
3. **^v** for "Quick options"
4. **OK** to confirm
5. **^v** for "Extended heating"
6. **OK** to confirm
7. Use **^v** as applicable for the required heating circuit or "All heating circuits"
8. **OK** to confirm
9. **OK** to switch the function off.
10. **OK** to acknowledge the information
11. **≡** for approx. 4 s to exit the menu.

## Adjusting the room temperature for longer periods at home

### Note

*Only for weather-compensated or continuous operation.*

If you are continuously at home for one or more days but you don't want to change the time program, select the "**Day(s) at home**" function. E.g. for public holidays or when the children are on school holidays.

The "**Day(s) at home**" function has the following effect:

- The room temperature during the periods between the set time phases is raised to the set value of the first time phase of the day: From reduced room temperature to standard room temperature or comfort room temperature.
- If no time phase is active before 0:00 h, your rooms are heated to the reduced room temperature until the next time phase becomes active.
- DHW heating is active.
- The "**Day(s) at home**" function starts and ends in accordance with the set duration in days.

### Note

*If "**Detached house**" was selected by your contractor during commissioning, the "**Day(s) at home**" function is adopted for all heating circuits.*

**Adjusting the room temperature for longer... (cont.)**

**Example**

For Monday and Tuesday, 2 time phases are set respectively.

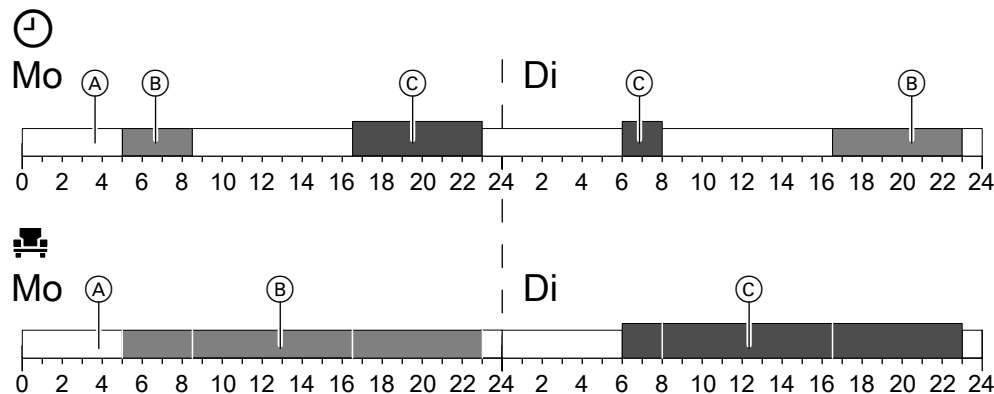

Fig. 2

- ⊙ Temperature levels in line with the set time program
- ☰ Temperature level, if "Day(s) at home" is switched on
- Ⓐ Reduced room temperature
- Ⓑ Standard room temperature
- Ⓒ Comfort room temperature

**Switching on "Day(s) at home" ☰**

Tap the following on-screen buttons:



1. Call up the home screen.
2. ☰
3. ^v for "Quick options"
4. OK to confirm
5. ^v for "Day(s) at home"
6. OK to confirm
7. Use ^v to select the required heating circuit.
8. OK to confirm
9. ^v for "Activate"
10. OK to confirm
11. ^v to set the number of days after which "Day(s) at home" begins:  
"0" Today  
"1" Tomorrow  
"2" in 2 days  
... etc.
12. OK to confirm
13. ^v for the duration in days
14. OK to confirm
15. OK to acknowledge the information
16. ☰ for approx. 4 s to exit the menu.

**Changing "Day(s) at home"**

Tap the following on-screen buttons:







1. Call up the home screen.
2. ☰
3. ^v for "Quick options"
4. OK to confirm
5. ^v for "Day(s) at home"
6. OK to confirm
7. Use ^v to select the required heating circuit.
8. OK to confirm
9. ^v for "Modify"

## Adjusting the room temperature for longer... (cont.)

10. **OK** to confirm
11.  to set the number of days after which "Day(s) at home" begins:
  - "0" Today
  - "1" Tomorrow
  - "2" in 2 days
  - ... etc.
12. **OK** to confirm
13.  for the duration in days
14. **OK** to confirm
15. **OK** to acknowledge the information
16.  for approx. 4 s to exit the menu.

## Switching off "Day(s) at home"

Tap the following on-screen buttons:

1. Call up the home screen.
2. 
3.  for "Quick options"
4. **OK** to confirm
5.  for "Day(s) at home"
6. **OK** to confirm
7. Use  to select the required heating circuit.
8. **OK** to confirm
9.  for "Stop"
10. **OK** to confirm
11. **OK** to acknowledge the information
12.  for approx. 4 s to exit the menu.

## Saving energy during long periods of absence

### Note

Only for weather-compensated or continuous operation.

To save energy during long periods of absence, select the "Holiday" program.

The holiday program has the following effects:

- **Central heating:**
  - For heating circuits in the "ON" operating program: The rooms are heated to the set reduced room temperature.
  - For heating circuits in the "OFF" operating program: No central heating: Frost protection for the heat generator and the DHW cylinder is enabled.
- **DHW heating:** No DHW heating; frost protection for the DHW cylinder is enabled.
- The "Holiday" program starts at 00:00 h on the first day of the holiday and ends at 23:59 h on the last day of the holiday.

### Note







- If "**Detached house**" was selected by your contractor during commissioning, the holiday program is switched on for all heating circuits.
- If "**Apartment building**" was selected by your contractor during commissioning, DHW heating will only be switched off if all heating circuits are in the holiday program.

## Switching on "Holiday"

Tap the following on-screen buttons:

1. Call up the home screen.
2. 
3.  for "Quick options"









### Saving energy during long periods of absence (cont.)

4. **OK** to confirm
5.  for "Holiday"
6. **OK** to confirm
7. Use  to select the required heating circuit.
8. **OK** to confirm
9.  for "Activate"
10. **OK** to confirm
11.  to set the number of days after which "Holiday" begins:  
"0" Today  
"1" Tomorrow  
"2" in 2 days  
... etc.
12. **OK** to confirm
13.  for the number of days' holiday
14. **OK** to confirm
15. **OK** to acknowledge the information
16.  for approx. 4 s to exit the menu.

---

### Changing "Holiday"







Tap the following on-screen buttons:

1. Call up the home screen.
2. 
3.  for "Quick options"
4. **OK** to confirm
5.  for "Holiday"
6. **OK** to confirm
7. Use  to select the required heating circuit.
8. **OK** to confirm
9.  for "Modify"
10. **OK** to confirm
11.  to set the number of days after which "Holiday" begins:  
"0" Today  
"1" Tomorrow  
"2" in 2 days  
... etc.
12. **OK** to confirm
13.  for the number of days' holiday
14. **OK** to confirm
15. **OK** to acknowledge the information
16.  for approx. 4 s to exit the menu.

---

### Switching off "Holiday"

Tap the following on-screen buttons:

1. Call up the home screen.
2. 
3.  for "Quick options"
4. **OK** to confirm
5.  for "Holiday"
6. **OK** to confirm
7. Use  to select the required heating circuit.
8. **OK** to confirm
9.  for "Stop"
10. **OK** to confirm
11. **OK** to acknowledge the information
12.  for approx. 4 s to exit the menu.





## DHW temperature

Factory settings: 50 °C

### Note

For reasons of good hygiene, you should not set the DHW temperature lower than 50 °C.





Tap the following on-screen buttons:

1. Call up the home screen.
2. 
3.  for "Temperature levels"
4. **OK** to confirm
5.  for "DHW"
6. **OK** to confirm
7. **OK** to confirm "Set"
8. Use  to select the required heating circuit.
9. **OK** to confirm
10. **OK** to acknowledge the information
11.  for approx. 4 s to exit the menu.

## Switching DHW heating on or off (operating program)

If you switch off DHW heating, no water can be heated. This also applies to the "One-off DHW heating" function.

Tap the following on-screen buttons:

1. Call up the home screen.
2. 
3.  for "Turn on/off"
4. **OK** to confirm
5.  for "DHW" or "Entire system"
6. **OK** twice to confirm
7.  for "ON" or "OFF"
8. **OK** to confirm
9. **OK** to acknowledge the information
10.  for approx. 4 s to exit the menu.

For information on the operating programs, see page 17.





## One-off DHW heating outside the time program

If you require hot water outside the set time phases, switch on "One-off DHW heating". The DHW cylinder is heated once to the set DHW temperature.

This function has a higher priority than other functions, such as the time program for example.

### Switching on "One-off DHW heating"

Tap the following on-screen buttons:

1. Call up the home screen.
2. 
3.  for "Quick options"
4. **OK** to confirm
5.  for "One-off heating"
6. **OK** to confirm
7.  for "Activate"
8. **OK** to confirm
9. **OK** to acknowledge the information

### One-off DHW heating outside the time program (cont.)

#### Switching off "One-off DHW heating"

"One-off DHW heating" ends as soon as the set DHW temperature has been reached.

#### Note

*It is not possible to end DHW heating sooner.*

### Increased DHW hygiene

You can heat the water in the DHW cylinder to above 60 °C once a week or for an hour every day. This function is regularly carried out at the specified time.



#### Danger

High DHW temperatures can cause scalding, e.g. if the DHW temperature is above 60 °C. Mix with cold water at the draw-off points.

#### Switching on the "Hygiene program"

Tap the following on-screen buttons:

1. Call up the home screen.
- 2.
3. for "Time programs"
4. **OK** to confirm
5. for "DHW"
6. **OK** to confirm
7. for "Hygiene program"
8. **OK** to confirm
9. for the required day or daily
10. **OK** to confirm
11. for the required time (hours)
12. **OK** to confirm
13. for the required time (minutes)
14. to confirm
15. for approx. 4 s to exit the menu.

#### Switching off the "Hygiene program"

Tap the following on-screen buttons:

1. Call up the home screen.
- 2.
3. for "Time programs"
4. **OK** to confirm
5. for "DHW"
6. **OK** to confirm
7. for "Hygiene program"
8. **OK** to confirm
9. for "Stop"
10. **OK** to confirm
11. **OK** to confirm
12. **OK** to acknowledge the information

#### Switching DHW scald protection on/off

Tap the following on-screen buttons:

1. Call up the home screen.
- 2.
3. for "Temperature levels"
4. **OK** to confirm
5. for "DHW"
6. **OK** to confirm
7. for "Scald protection"

**Increased DHW hygiene** (cont.)

8. **OK** to confirm
9.  for "On" or "Off"
10. **OK** to confirm







**Note**

*With scald protection switched off, a set DHW temperature of over 60 °C can be selected, depending on the heat generator. There is an increased risk of scalding!*

## Further adjustments

### Setting the display brightness

#### Tap the following on-screen buttons:

1. Call up the home screen.
2. 
3.  for "Settings"
4. **OK** to confirm
5.  for "Display brightness"
6. **OK** to confirm
7.  for "Display"
8. **OK** to confirm
9.  for the selected value
10. **OK** to confirm
11.  for approx. 4 s to exit the menu.

### Switching the "Lightguide" on and off

Depending on the type of heat generator, a red illuminated strip (Lightguide) is displayed at the lower or upper edge of the control unit during operation. In the delivered condition, the Lightguide is switched on. You can switch off the Lightguide.

Meaning of the display:

- Lightguide pulsates slowly:  
Display is in standby mode.
- Lightguide is illuminated constantly:  
You are operating the control unit. Every input operation is confirmed by a brief flashing.
- Lightguide flashes quickly:  
There is a fault on the system.

#### Tap the following on-screen buttons:

1. Call up the home screen.
2. 
3.  for "Settings"
4. **OK** to confirm
5.  for "Display brightness"
6. **OK** to confirm
7.  for "Lightguide"
8. **OK** to confirm
9.  for "ON" or "OFF"
10. **OK** to confirm
11.  for approx. 4 s to exit the menu.

#### Note







*Faults are shown by flashing lights even if the Lightguide is switched off.*

### Setting the "Time" and "Date"

The "Time" and "Date" are set at the factory. If your system has been shut down for a prolonged period, you may need to reset the "Time" and "Date".

#### Set time

#### Tap the following on-screen buttons:

1. Call up the home screen.
2. 
3.  for "Settings"
4. **OK** to confirm
5.  for "Date and time"
6. **OK** to confirm
7.  for "Time"
8. **OK** to confirm
9.  for "Time"
10. **OK** to confirm
11.  for the hours









## Setting the "Time" and "Date" (cont.)

- |   |   |
|---|---|
| 12. <b>OK</b> to confirm  | 14. <b>OK</b> to confirm  |
| 13.  for the minutes | 15.  for approx. 4 s to exit the menu. |









### Setting the format for the time

Tap the following on-screen buttons:

- |   |  |
|---|--|
| 1. Call up the home screen.   | 8. <b>OK</b> to confirm  |
| 2.                               | 9.  for " <b>Format</b> "   |
| 3.  for " <b>Settings</b> "      | 10. <b>OK</b> to confirm   |
| 4. <b>OK</b> to confirm   | 11.  for the required format:<br><ul style="list-style-type: none"> <li>▪ "12 h"</li> <li>▪ "24 h"</li> </ul> |
| 5.  for " <b>Date and time</b> " | 12. <b>OK</b> to confirm   |
| 6. <b>OK</b> to confirm   | 13.  for approx. 4 s to exit the menu.  |
| 7.  for " <b>Time</b> "          |  |







### Set the date

Tap the following on-screen buttons:

- |   |   |
|---|---|
| 1. Call up the home screen.   | 9.  for " <b>Date</b> "                |
| 2.                               | 10. <b>OK</b> to confirm  |
| 3.  for " <b>Settings</b> "      | 11.  for the year                      |
| 4. <b>OK</b> to confirm   | 12. <b>OK</b> to confirm  |
| 5.  for " <b>Date and time</b> " | 13.  for the month                     |
| 6. <b>OK</b> to confirm   | 14. <b>OK</b> to confirm  |
| 7.  for " <b>Date</b> "          | 15.  for the day                       |
| 8. <b>OK</b> to confirm   | 16. <b>OK</b> to confirm  |
|   | 17.  for approx. 4 s to exit the menu. |

### Setting the format for the date

Tap the following on-screen buttons:

- |   |  |
|---|--|
| 1. Call up the home screen.   | 7.  for " <b>Date</b> "   |
| 2.                               | 8. <b>OK</b> to confirm  |
| 3.  for " <b>Settings</b> "      | 9.  for " <b>Format</b> "   |
| 4. <b>OK</b> to confirm   | 10. <b>OK</b> to confirm   |
| 5.  for " <b>Date and time</b> " | 11.  for the required format:<br><ul style="list-style-type: none"> <li>▪ "DD.MM.YYYY"</li> <li>▪ "MM/DD/YYYY"</li> <li>▪ "YYYY-MM-DD"</li> </ul> |
| 6. <b>OK</b> to confirm   | 12. <b>OK</b> to confirm   |

## Further adjustments

### Setting the "Time" and "Date" (cont.)

13. ☰ for approx. 4 s to exit the menu.

### Summer/wintertime automatic changeover

Tap the following on-screen buttons:

1. Call up the home screen.
2. ☰
3. ^v for "Settings"
4. OK to confirm
5. ^v for "Date and time"
6. OK to confirm
7. ^v for "Time"
8. OK to confirm
9. ^v for "Time changeover"
10. OK to confirm
11. ^v for "ON" or "OFF"
12. OK to confirm
13. ☰ for approx. 4 s to exit the menu.

### Setting the "Language"

Tap the following on-screen buttons:

1. Call up the home screen.
2. ☰
3. ^v for "Settings"
4. OK to confirm
5. ^v for "Language"
6. OK to confirm
7. ^v for the required language
8. OK to confirm
9. ☰ for approx. 4 s to exit the menu.

### Setting "Units"

You can adjust all available units, e.g. for the temperature, pressure, etc.

#### Note

The format for date and time can be set in the "Date and time" menu.







Tap the following on-screen buttons:

1. Call up the home screen.
2. ☰
3. ^v for "Settings"
4. OK to confirm
5. ^v for "Units"
6. OK to confirm
7. ^v for the required unit, e.g. "Temp./length" or "Pressure"
8. OK to confirm
9. ^v for the required setting
10. OK to confirm
11. ☰ for approx. 4 s to exit the menu.

## Switching on wireless connection to the remote control

With weather-compensated operation, you can connect your remote control to the control unit for wireless data transfer via low power radio.

Tap the following on-screen buttons:

1. Call up the home screen.
2. 
3.  for "Settings"
4. **OK** to confirm
5.  for "Accessories"
6. **OK** to confirm
7.  for "Device status"
8. **OK** to confirm
9.  for "Low power radio"
10. **OK** to confirm
11.  for "ON" or "OFF"
12. **OK** to confirm
13.  for the required setting
14. **OK** to confirm

15. **OK** to acknowledge the information

16.  for approx. 4 s to exit the menu.

Calling up the "Low power radio" credentials

Tap the following on-screen buttons:

1. Call up the home screen.
2. 
3.  for "Settings"
4. **OK** to confirm
5.  for "Accessories"
6. **OK** to confirm
7.  for "Information"
8. **OK** to confirm
9. Credentials "IC" and "EUI-64"
10. **OK** to confirm
11. **OK** to acknowledge the information
12.  for approx. 4 s to exit the menu.

## Switching internet access on or off

You can control your system remotely via the internet using an app. To do this, establish an internet connection via WiFi (2.4 gigahertz): See the following chapter. The required credentials for internet access to the control unit via app can be found on the adjacent label:

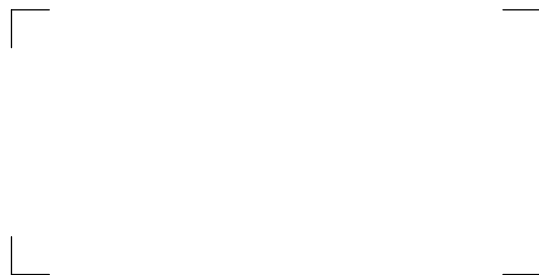

## Establishing a WiFi connection

Tap the following on-screen buttons:

1. Call up the home screen.
2. 
3. Press and hold **OK** for approx. 4 s. Information is displayed.

## Further adjustments

### Switching internet access on or off (cont.)

4. Follow the instructions in the app.

**Note**

*The credentials can be found on the label.*

**Fault while establishing the connection**

**"E10"** *Connection to the home network cannot be established.*

**Note**

*If "E10" appears on the display, check the connection to the router and whether the network password is correct.*

**"E12"** *Connection to the server cannot be established.*

**Note**

*If "E12" appears on the display, re-establish the connection at a later time.*

5. At the end, **OK** to confirm
6. **OK** to acknowledge the information
7. **≡** for approx. 4 s to exit the menu.

### Switching WiFi on and off

Tap the following on-screen buttons:

1. Call up the home screen.

2. **∨** + **OK** should be pressed simultaneously for approx. 4 s.

### Restoring factory settings

You can reset all entries and values to their factory settings.

Settings and values that are reset with all operating modes:

- Standard room temperature or standard flow temperature
- Reduced room temperature or reduced flow temperature
- Operating program
- DHW temperature
- Time program for DHW heating
- Time program for DHW circulation pump

Settings and values that are additionally reset with weather-compensated operation or continuous operation:

- Comfort room temperature or comfort flow temperature
- Time program for central heating

- **"Extended heating"** is switched off.
- **"Holiday"** and **"Day(s) at home"**
- Only for weather-compensated operation: Heating curve slope and level

Tap the following on-screen buttons:

1. Call up the home screen.
2. **≡**
3. **∧∨** for **"Settings"**
4. **OK** to confirm
5. **∧∨** for **"Factory settings"**
6. **OK** to confirm
7. **OK** to acknowledge the information

## Calling up help messages

You can call up help messages relating to some of the displays and functions.

Tap the following on-screen buttons:

1. In the menu, use   as applicable for "Help"

2. **OK** to confirm
3.  to exit the screen

## Checking information

Depending on the system equipment level and the settings made, you can call up current system data, e.g. temperatures.

The system data is divided into the following groups:

- General
- Burner
- Heating circuit 1
- Only for weather-compensated or continuous operation:
  - Additional heating circuits
- DHW for domestic hot water
- Solar
- WiFi











### Note

*If names have been given to the heating circuits, the allocated name is shown: See page 23.*

*Detailed options for checking the individual groups can be found in chapter "Menu overview".*

Tap the following on-screen buttons:

1. Call up the home screen.

2. 
3.   for "Information"
4. **OK** to confirm
5.   for "Device status"
6. **OK** to confirm
7.   for the required group
8. **OK** to confirm
9.   for the required information
10.  for approx. 4 s to exit the menu.

## Calling up the contact details for your contractor

Tap the following on-screen buttons:

1. Call up the home screen.
2. 
3.   for "Information"
4. **OK** to confirm
5.   for "Contractor"
6. **OK** to confirm
7.  for approx. 4 s to exit the menu.

## Calling up the energy balance

You can call up the following consumption values:

- Gas condensing boiler fuel consumption:
  - Gas consumption for central heating
  - Gas consumption DHW
  - Total gas consumption
- Electricity consumption
- Solar yield

Tap the following on-screen buttons:

1. Call up the home screen.
2. 
3.   for "Energy metering"
4. **OK** to confirm
5.   to select "Consumption" or "Solar yield".
6. **OK** to confirm
7.   for the required period





## Checks

### Checking information (cont.)

8. **OK** to confirm
9.  for approx. 4 s to exit the menu.

#### Setting the gross calorific value and gas volume correction factor for consumption calculation

Tap the following on-screen buttons:

1. 
2.  for "Energy metering"
3. **OK** to confirm
4.  for "Consumption"
5. **OK** to confirm
6. "Settings"
7. Select gross calorific value or gas volume correction factor.
8. **OK** to confirm
9.  – press and hold and set the value.

10. **OK** to confirm
11.  – press and hold and set the value for the decimal place.
12. **OK** to confirm

#### Note

The value can be found on the gas bill. The values entered are used to help calculate the gas consumption.





#### Note

The consumption figures displayed are not based on metering equipment but instead are computed values. The calculation takes into account the existing system components and the user behaviour (e.g. operating time and utilisation level). Depending on system-specific parameters (e.g. installation altitude and type of flue system), differences may arise between the displayed (computed) and actual consumption values. Due to seasonal climate conditions and other factors, further discrepancies are possible. The value display serves to visualise the energy flow to date, as well as any consumption increases or decreases in relation to specific comparative periods. It cannot be used as a binding basis for billing.

### Calling up licenses for the programming unit

Calls up the licence for the programming unit.

Tap the following on-screen buttons:

1. Call up the home screen.
2. 
3.  for "Information"
4. **OK** to confirm
5.  for "Device information"
6. **OK** to confirm
7.  for "Open source licences"
8. **OK** to confirm
9.  for approx. 4 s to exit the menu.

### Calling up licenses for the integrated wireless module

Switch on the WiFi to call up online legal information, such as open source licences:

In the home screen, press and hold **OK** for approx. 4 s.

### Calling up the license information for third party components

Requirement: Access point must be switched on.

Tap the following buttons:

1. Call up the WiFi settings on your mobile device.
2. Connect your mobile device to the WiFi "Viessmann-<xxxx>".  
A password prompt will be displayed.

## Calling up licenses for the integrated wireless... (cont.)

3. Enter the WPA2 network key as the password for the "**Viessmann-<xxxx>**" WiFi.
 

**Note**  
The WPA2 network key can be found on the label:  
See chapter "Switching internet access on or off".
4. With your connected mobile device, open **http://192.168.0.1** in your internet browser.
5. Follow the link "**Third party Components Licences**".

## Third party software

### 1 Overview

This product contains third party software, including open source software. You are authorised to use this third party software subject to compliance with the relevant licensing terms as provided in this document. A list of used third party software components and of license texts can be accessed by connecting your boiler, like it is mentioned in the manual.

### 2 Acknowledgements

Linux® is the registered trademark of Linus Torvalds in the U.S. and other countries. This product includes software developed by the OpenSSL Project for use in the OpenSSL Toolkit (<http://www.openssl.org/>). This product includes cryptographic software written by Eric Young ([ey@cryptsoft.com](mailto:ey@cryptsoft.com)) and software written by Tim Hudson ( [tjh@cryptsoft.com](mailto:tjh@cryptsoft.com) ).

### 3 Disclaimer

The open source software contained in this product is distributed WITHOUT ANY WARRANTY; without even the implied warranty of MERCHANTABILITY or FITNESS FOR A PARTICULAR PURPOSE. The single licences may contain more details on a limitation of warranty or liability.

### 5 Contact information

Viessmann Climate Solutions SE  
D-35108 Allendorf  
Germany  
Fax +49 64 52 70-27 80  
Phone +49 64 52 70-0  
[open-source-software-support@viessmann.com](mailto:open-source-software-support@viessmann.com)  
[www.viessmann.de](http://www.viessmann.de)

### 4 How to obtain the source code

The software included in this product may contain copyrighted software that is covered under a licence requiring us to provide the source code of that software, such as the GPL or LGPL. To obtain the complete corresponding source code for such copyrighted software, please get in touch with us via the contact information provided in section 5 below indicating the build number you will find in the licensing information section, which can be accessed as outlined in this document. This offer is not limited in time and is valid to anyone in receipt of this information.







## Checking service messages

Your contractor can set service intervals. "**Active messages**" is displayed if these service intervals are exceeded.

Tap the following on-screen buttons:

1. **OK** to confirm
2. 

## Checking service messages (cont.)

3.   for "Active messages"
4. **OK** to confirm
5.   for "Maintenance"
6. **OK** to confirm
7.   for the required message
8. **OK** to confirm  
Further information regarding the message is displayed.
9. Make a note of the service message number. For example: **P.1 "Interval until the next service"**. This enables the contractor to be better prepared and may save you unnecessary travelling costs.
10. Please notify your heating contractor.

**Note**

*If the service cannot be carried out until a later date, the service message will be displayed again the following Monday.*

11.  for approx. 4 s to exit the menu.

## Checking fault messages

If your system has developed faults, "Burner fault" or "Active messages" are displayed. The Lightguide is flashing: See chapter "Switching the Lightguide on and off".



**Danger**

If faults are not rectified, they can have life threatening consequences. Do not acknowledge fault messages several times in quick succession. Please notify your heating contractor if a fault occurs. Your contractor will be able to analyse the cause and rectify the fault.











**Note**

- *If you have connected a message facility to alert you to fault messages (e.g. a buzzer), this is deactivated when the fault message is acknowledged.*
- *If troubleshooting cannot be carried out until a later date, the fault message will be displayed again the following day at 07:00 h. The message facility is switched on again.*

### Burner fault





Shown on display: "The burner control unit is locked out"

Tap the following on-screen buttons:

1.   for "Ignore"
2. **OK** to confirm  
The burner remains locked out.
3. **OK** to acknowledge the information
4.  should be pressed for approx. 4 s.
5. 
6.   for "Active messages"
7. **OK** to confirm
8.   for "Faults"
9. **OK** to confirm
10.   for the required message
11. **OK** to confirm  
Further information regarding the message is displayed.
12. Make a note of the fault number. This enables the contractor to be better prepared and may save you unnecessary travelling costs.
13. Please notify your heating contractor.
14.  for approx. 4 s to exit the menu.







**Faults without burner fault**

Tap the following on-screen buttons:

1. **OK** to confirm
2.  should be pressed for approx. 4 s.
3. 
4.   for "Active messages"



## Checking fault messages (cont.)

5. **OK** to confirm
6.  for "Error message"
7. **OK** to confirm
8.  for the required message
9. **OK** to confirm  
Further information regarding the message is displayed.
10. Make a note of the fault number. For example: **F.160 "Communication error CAN bus"**.  
This enables the contractor to be better prepared and may save you unnecessary travelling costs.
11.  to go back a step in the menu
12.  for further messages
13.  to go back a step in the menu
14.  for "Contractor"  
The contact details of your heating contractor are displayed (if your contractor has entered them).
15. Please notify your heating contractor.
16.  for approx. 4 s to exit the menu.

## Resetting the burner after a burner fault

If the burner is locked due to a fault, you can reset the burner.



**Reset via home screen:**



**Tap the following on-screen buttons:**

1.  for "Unlock"
2. **OK** to confirm

**Reset via submenu:**

**Tap the following on-screen buttons:**

1. **OK** to confirm
2.  should be pressed for approx. 4 s.
3. 
4.  for "Active messages"

5. **OK** to confirm
6.  for "Burner fault"
7. **OK** to confirm
8.  for "Unlock"
9. **OK** to confirm
10. **OK** to acknowledge the information
11.  for approx. 4 s to exit the menu.





### **Danger**

If faults are not rectified, they can have life threatening consequences.

Do not reset the burner several times in quick succession. Immediately notify your contractor if a burner fault occurs. Your contractor will be able to analyse the cause and rectify the fault.





## Acknowledging messages

**Tap the following on-screen buttons:**

1. Call up the home screen.
2. 
3.  for "Active messages"
4. **OK** to confirm
5.  for "Acknowledge"
6. **OK** to confirm
7. **OK** to acknowledge the information  
**All pending messages are acknowledged.**

### Checking message lists

Tap the following on-screen buttons:

1. Call up the home screen.
2. 
3.  for "Active messages"
4. OK to confirm
5.  for the required type of message
6. OK to confirm  
The messages are shown listed.
7.  for the required message
8. OK to confirm  
Further information regarding the message is displayed.
9.  for approx. 4 s to exit the menu.

If there are any corresponding messages:

- "Burner faults"
- "Faults"
- "Warnings"
- "Maintenance"
- "Status"
- "Information"

## Emissions test mode



The emissions test mode for testing flue gas must only be activated by your flue gas inspector during the annual inspection.

If possible, have the emissions test carried out during the heating season.

---

### Switching on emissions test mode

Tap the following on-screen buttons:

1. Call up the home screen.
2. 
3.  for "Test mode"
4. **OK** to confirm
5. **OK** to acknowledge the start

6. Follow the instructions on the display. If test mode is possible, the burner starts. The flow temperature of the heat generator and burner status are shown on the display.

**Note**

*Ensure adequate heat transfer during emissions test mode.*

---





### Stopping emissions test mode

- Automatically after 30 minutes
- Or
- Tap .

### Switching the system off

#### Switching off heat generation with frost protection monitoring ("Switch off")

Tap the following on-screen buttons:

1. Call up the home screen.
2. 
3.  for "Turn on/off"
4. **OK** to confirm
5.  for "Entire system"
6. **OK** twice to confirm
7.  for "Off"
8. **OK** to confirm
9. **OK** to acknowledge the information

10.  for approx. 4 s to exit the menu.

#### Note

If the menu "**Entire system**" is not available, set "**Heating**" and "**DHW**" to "**Off**", one after the other.

- No central heating
- No DHW heating
- Frost protection for the heat generator and the DHW cylinder is enabled.

#### Note

- All circulation pumps connected to the control unit are briefly started every 24 hours to prevent them from seizing up.
- The diverter valves are switched over at regular intervals.

---

#### Switching off heat generation without frost protection monitoring

- No central heating
- No DHW heating
- Frost protection for the heat generator and the DHW cylinder is **not** enabled.

1. Turn off the ON/OFF switch: See page 45).
2. Close the gas shut-off valve.



#### Please note

If outside temperatures of below 3 °C are expected, take appropriate measures to protect the system from frost.  
If necessary, contact your contractor.

#### Note

- As they are not being supplied with power, the circulation pumps and diverter valves may seize up.
- If your system has been shut down for a prolonged period, you may need to reset the "**Time**" and "**Date**": See page 32.

## Switching system on

Vitodens 200-W

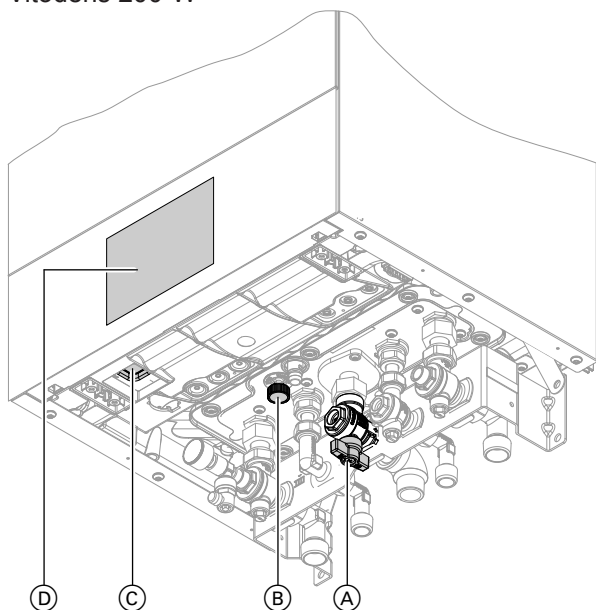

Fig. 3

**Note**

The control unit can be located at the top or bottom.

- (A) Gas shut-off valve
- (B) Drain & fill valve
- (C) ON/OFF switch
- (D) System pressure (shown on display)

Vitodens 222-W

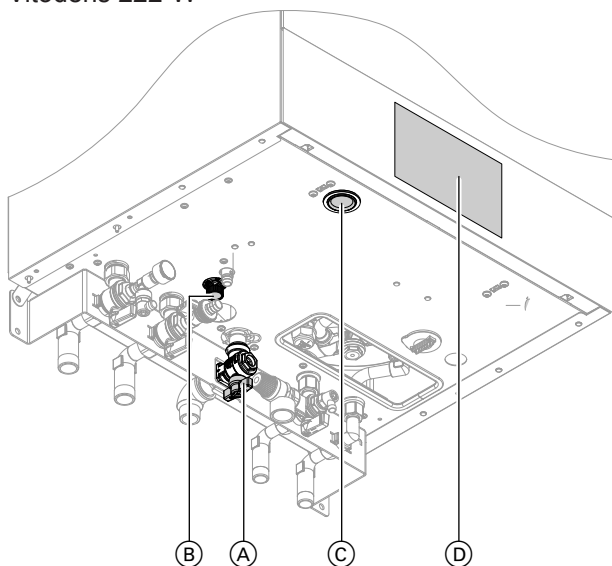

Fig. 4

**Note**

The control unit can be located at the top or bottom.

- (A) Gas shut-off valve
- (B) Drain & fill valve
- (C) ON/OFF switch
- (D) System pressure (shown on display)

Vitodens 222-F and Vitodens 242-F

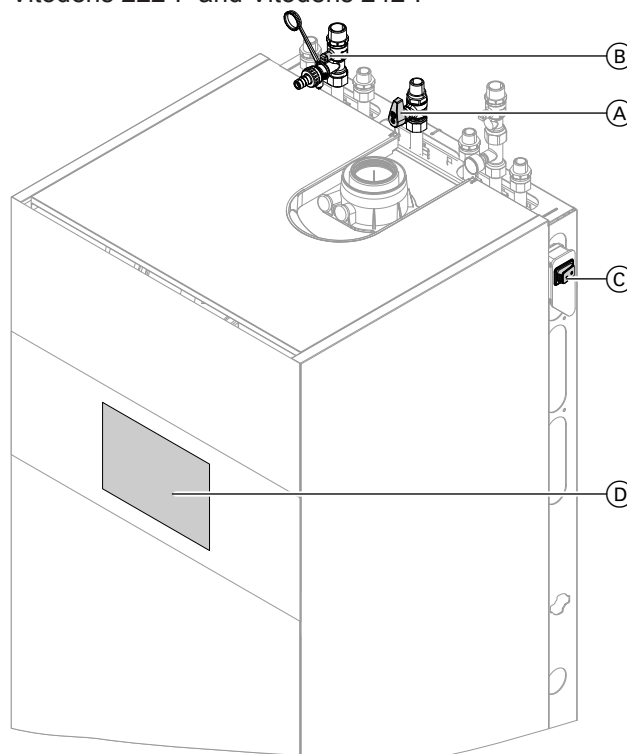

Fig. 5 Example with connections at the top

- (A) Gas shut-off valve
- (B) Drain & fill valve
- (C) ON/OFF switch
- (D) System pressure (shown on display)

Ask your contractor about the following:

- Required system pressure
- Position of ventilation apertures in the installation room, if applicable

1. Open gas shut-off valve (A).
2. Check that the power supply to your system is switched on, e.g. at a separate MCB/fuse or mains isolator.

**Note**

The power supply to the system was switched on by your heating contractor during commissioning. If possible, do not interrupt the power supply, even when the system is in standby mode.



3. Turn ON/OFF switch (C) on.
  - After a short while, the home screen is shown on the display.
  - The Lightguide is illuminated constantly. Your system and, if installed, your remote controls are ready for operation.

## Switching on and off

### Switching system on (cont.)

4. Check the system pressure:
  -  for "**System pressure**"
  - If the pressure shown is below 1.0 bar:  
Please top up with water or notify your heating contractor.

## Rooms are too cold

Cause	Remedy
The heat generator is switched off.	<ul style="list-style-type: none"> <li>▪ Turn on the ON/OFF switch: See page 45.</li> <li>▪ Switch ON the power supply to your system, e.g. at a separate MCB/fuse or mains isolator.</li> </ul>
<ul style="list-style-type: none"> <li>▪ Incorrect control unit settings.</li> <li>▪ The remote control (if installed) or the room temperature controller (if installed) is set incorrectly.</li> </ul>  <p>Operating instructions, for the remote control unit or room temperature controller</p>	<p>Central heating must be enabled.</p> <p>Check the settings and correct if required:</p> <ul style="list-style-type: none"> <li>▪ Operating program: See page 17.</li> <li>▪ Room temperature/flow temperature: See page 23.</li> <li>▪ Time: See page 32.</li> <li>▪ Time program for central heating: See page 19.</li> <li>▪ Only for weather-compensated operation: Heating curve: See page 24.</li> <li>▪ Only for weather-compensated or continuous operation: "Holiday" is switched on: See page 27.</li> </ul>
The DHW cylinder is being heated.	Wait until the DHW cylinder has been heated up. Reduce the DHW draw-off rate or temporarily reduce the set DHW temperature as required.
No fuel.	Open the gas shut-off valve. If necessary, check with your gas supply utility.
"Burner fault" is displayed.	<p>Reset the burner: See page 41.</p> <p> <b>Danger</b> If faults are not rectified, they can have life threatening consequences. Do not reset the burner several times in quick succession. Immediately notify your contractor if a burner fault occurs. Your contractor will be able to analyse the cause and rectify the fault.</p>
"Error message" is displayed.	Check what type of fault it is. Make a note of the fault message and acknowledge the fault: See page 40. If necessary, notify your contractor.
"Screed drying" is switched on.	<p>No action required.</p> <p>After expiry of the screed drying time, the selected operating program is switched on.</p>

## Rooms are too hot

Cause	Remedy
<ul style="list-style-type: none"> <li>▪ Incorrect control unit settings.</li> <li>▪ The remote control (if installed) or the room temperature controller (if installed) is set incorrectly.</li> </ul>  Operating instructions, for the remote control unit or room temperature controller	<p>Check the settings and correct if required:</p> <ul style="list-style-type: none"> <li>▪ Operating program: See page 17.</li> <li>▪ Room temperature/flow temperature: See page 23.</li> <li>▪ Time: See page 32.</li> <li>▪ Time program for central heating: See page 19.</li> <li>▪ Only for weather-compensated operation: Heating curve: See page 24.</li> <li>▪ Only for weather-compensated or continuous operation:                             <ul style="list-style-type: none"> <li>"Day(s) at home" is switched on: See page 25.</li> </ul> </li> <li>▪ Only for weather-compensated or continuous operation:                             <ul style="list-style-type: none"> <li>"Extended heating" is switched on: See page 24.</li> </ul> </li> </ul>
"Error message" is displayed.	Check what type of fault it is. Make a note of the fault message and acknowledge the fault: See page 40. If necessary, notify your contractor.
"Screed drying" is switched on	No action required. After expiry of the screed drying time, the selected operating program is switched on.

## There is no hot water

Cause	Remedy
The heat generator is switched off.	<ul style="list-style-type: none"> <li>▪ Turn on the ON/OFF switch: See page 45.</li> <li>▪ Switch ON the power supply to your system, e.g. at a separate MCB/fuse or mains isolator.</li> </ul>
<ul style="list-style-type: none"> <li>▪ Incorrect control unit settings.</li> <li>▪ The remote control (if installed) or the room temperature controller (if installed) is set incorrectly.</li> </ul>  Operating instructions, for the remote control unit or room temperature controller	<p>DHW heating must be enabled.</p> <p>Check the settings and correct if required:</p> <ul style="list-style-type: none"> <li>▪ Operating program: See page 17.</li> <li>▪ DHW temperature: See page 29.</li> <li>▪ Time: See page 32.</li> <li>▪ Time program for DHW heating: See page 22.</li> <li>▪ Only for weather-compensated or continuous operation:                             <ul style="list-style-type: none"> <li>"Holiday" is switched on for all heating circuits: See page 27.</li> </ul> </li> </ul>
No fuel.	Open the gas shut-off valve. If necessary, check with your gas supply utility.
"Error message" is displayed.	Check what type of fault it is. Make a note of the fault message and acknowledge the fault: See page 40. If necessary, notify your contractor.
"Screed drying" is switched on.	No action required. After expiry of the screed drying time, the selected operating program is switched on.
"Filter strainer" is dirty. (Gas condensing combi boilers only)	Have the filter strainer checked/replaced by a heating contractor.



**The DHW is too hot**

Cause	Remedy
Incorrect control unit settings.	Check and correct the set DHW temperature if required: See page 29.
The hygiene function is switched on.	Wait until the hygiene function has been completed.
DHW temperature for solar DHW heating is set too high.	Have your contractor change the setting.

**"Burner fault" is displayed**

Cause	Remedy
Burner fault	Proceed as described on page 40.

**"Active messages" is displayed**

Cause	Remedy
The time for a service as specified by your contractor has arrived. Or System fault	Proceed as described on page 39 or 40.

**"External hook-up" is displayed**

Cause	Remedy
The set operating program was changed over by an external device, e.g. an EM-EA1 extension (DIO electronics module): See page 18.	No action required. Once the external changeover no longer applies, the set operating program is switched on again.

**"Trade fair mode" is displayed**

Cause	Remedy
Trade fair mode is active. No heating, no DHW heating.	Notify your contractor.

## Maintenance

### Cleaning

The appliances can be cleaned with a commercially available domestic cleaning agent (non-scouring). Clean the surface of the programming unit with a microfibre cloth.

### Inspection and maintenance

The inspection and maintenance of a heating system is prescribed by the German Energy Saving Ordinance [EnEV] and the DIN 4755, DVGW-TRGI 2018, DIN 1988-8 and EN 806 standards.

Regular maintenance ensures trouble-free, energy efficient, environmentally responsible and safe heating. Your heating system must be serviced by an authorised contractor at least every 2 years. For this, it is best to arrange an inspection and maintenance contract with your local heating contractor.

### Appliance

Increased contamination raises the flue gas temperature and thereby increases energy losses. We recommend the appliance is cleaned annually.

### DHW cylinder

Standards DIN 1988-8 and EN 806 specify that maintenance and cleaning should be carried out no later than 2 years after commissioning and as required thereafter.

Only a qualified contractor should clean the inside of the DHW cylinder and the DHW connections.

If any water treatment equipment (e.g. a sluice or injection system) is installed in the cold water supply of the DHW cylinder, ensure this is refilled in good time. For this, observe the manufacturer's instructions.

### Safety valve (DHW cylinder)

The function of the safety valve must be checked every six months by the user or a contractor through venting (see valve manufacturer's instructions). The valve seat may become contaminated. Water may drip from the safety valve during a heat-up process. The outlet is open to the atmosphere.

**! Please note**  
Overpressure can cause damage.  
Do not close the safety valve.

### Potable water filter (if installed)

To maintain high hygienic standards, proceed as follows:

- Replace filter element on non-back flushing filters every six months (visual inspection every two months).
- On back flushing filters, back flush every two months.

## Damaged cables / lines

If there is damage to the connecting cables or lines of the appliance or externally installed accessories, these must be replaced with special cables or lines. Only use Viessmann cables / lines as replacement. For this, notify your qualified contractor.

## System overview menu

### Note

Depending on the features of your system, not all of the displays and checks listed may be available.

### Tap the following on-screen buttons:

1. Call up the home screen.
2.  for the required information.

### Heating circuit 1

Temperature level:	<ul style="list-style-type: none"> <li>▪ Standard</li> <li>▪ Reduced</li> <li>▪ Only for weather-compensated or continuous operation: Comfort</li> </ul>
Operating program:	<ul style="list-style-type: none"> <li>▪ Standby</li> <li>▪ Screed drying or External hook-up</li> <li>▪ Summer mode</li> <li>▪ Frost protection</li> <li>▪ Only for weather-compensated or continuous operation: Holiday, Day(s) at home or Extended heating</li> </ul>

### Only for weather-compensated or continuous operation:

#### Additional heating circuits

Temperature level:	<ul style="list-style-type: none"> <li>▪ Standard</li> <li>▪ Reduced</li> <li>▪ Comfort</li> </ul>
Operating program:	<ul style="list-style-type: none"> <li>▪ Standby</li> <li>▪ Screed drying or External hook-up</li> <li>▪ Summer mode</li> <li>▪ Frost protection</li> <li>▪ Holiday, Day(s) at home or Extended heating</li> </ul>

### DHW

ON or OFF
One-off DHW heating with actual value and set value alternating
Current set temperature

### Solar

Status solar thermal system
Solar yield
Current month
Last month

### WiFi

Connection status
SSID
Signal strength

## System overview menu (cont.)

### System pressure

Actual value

## Overview of main menu

### Note

Depending on the features of your system, not all of the displays and checks listed may be available.

2. 

3.  for the required menu.

Tap the following on-screen buttons:

1. Call up the home screen.

### Trade fair mode active

If the appliance has been set by the contractor to "demonstration" mode, e.g. for exhibitions. No central heating, hot water or frost protection available!

### Active messages (if there are any current messages)

Acknowledge (if there are faults or service messages)
Burner fault
Faults
Warnings
Maintenance
Status
Information
Contractor

### Quick options

Only for weather-compensated or continuous operation: Extended heating	Heating circuit 1 or Continuous operation
	Additional heating circuits
Only for weather-compensated or continuous operation: Holiday	Heating circuit 1
	Additional heating circuits
Only for weather-compensated or continuous operation: Day(s) at home	Heating circuit 1
	Additional heating circuits
One-off DHW heating	

**Overview of main menu** (cont.)**Temperature levels**

Heating circuit 1	
	Standard
	Reduced
	Only for weather-compensated or continuous operation: Comfort
Only for weather-compensated or continuous operation: Additional heating circuits	
	Standard
	Reduced
	Comfort
DHW	
	Set value

**Turn on/off**

Heating	
	Heating circuit 1
	Only for weather-compensated or continuous operation: Additional heating circuits
DHW	
	ON or OFF
Entire system	
	ON or OFF

**WiFi**

SSID	
Signal strength	
Status	

**Time programs**

Heating	
	Heating circuit 1
	Only for weather-compensated or continuous operation: Additional heating circuits
DHW	
	DHW
	DHW circulation pump
	Hygiene program

## Overview of main menu (cont.)

### Energy balance

--	--

### Consumption

	Current month				
	<table border="1"> <tr><td>Gas consumption heating</td></tr> <tr><td>Gas consumption DHW</td></tr> <tr><td>Total gas consumption</td></tr> <tr><td>Electricity consumption</td></tr> </table>	Gas consumption heating	Gas consumption DHW	Total gas consumption	Electricity consumption
Gas consumption heating					
Gas consumption DHW					
Total gas consumption					
Electricity consumption					
	Last month				
	<table border="1"> <tr><td>Gas consumption heating</td></tr> <tr><td>Gas consumption DHW</td></tr> <tr><td>Total gas consumption</td></tr> <tr><td>Electricity consumption</td></tr> </table>	Gas consumption heating	Gas consumption DHW	Total gas consumption	Electricity consumption
Gas consumption heating					
Gas consumption DHW					
Total gas consumption					
Electricity consumption					

### Information

	Device status																																
	<table border="1"> <tr> <td></td> <td>General</td> </tr> <tr> <td></td> <td> <table border="1"> <tr><td>System pressure</td></tr> <tr><td>Outside temperature</td></tr> <tr><td>Flow temperature</td></tr> <tr><td>Primary circuit pump, set speed</td></tr> <tr><td>Primary circuit pump, actual speed</td></tr> <tr><td>Flue gas temperature</td></tr> <tr><td>Burner</td></tr> <tr><td>Burner starts</td></tr> <tr><td>Burner hours run</td></tr> <tr><td>Thermal output</td></tr> <tr><td>Central fault message</td></tr> <tr><td>Screed drying prog.</td></tr> <tr><td>Diverter valve</td></tr> <tr><td>Time</td></tr> <tr><td>Date</td></tr> <tr><td>Boiler serial number</td></tr> <tr><td>Device serial number</td></tr> </table> </td> </tr> <tr> <td></td> <td>Burner</td> </tr> <tr> <td></td> <td> <table border="1"> <tr><td>Burner</td></tr> <tr><td>Burner hours run</td></tr> <tr><td>Burner starts</td></tr> <tr><td>Burner modulation</td></tr> <tr><td>Flow temperature</td></tr> <tr><td>Flue gas temperature</td></tr> <tr><td>Flow sensor</td></tr> </table> </td> </tr> </table>		General		<table border="1"> <tr><td>System pressure</td></tr> <tr><td>Outside temperature</td></tr> <tr><td>Flow temperature</td></tr> <tr><td>Primary circuit pump, set speed</td></tr> <tr><td>Primary circuit pump, actual speed</td></tr> <tr><td>Flue gas temperature</td></tr> <tr><td>Burner</td></tr> <tr><td>Burner starts</td></tr> <tr><td>Burner hours run</td></tr> <tr><td>Thermal output</td></tr> <tr><td>Central fault message</td></tr> <tr><td>Screed drying prog.</td></tr> <tr><td>Diverter valve</td></tr> <tr><td>Time</td></tr> <tr><td>Date</td></tr> <tr><td>Boiler serial number</td></tr> <tr><td>Device serial number</td></tr> </table>	System pressure	Outside temperature	Flow temperature	Primary circuit pump, set speed	Primary circuit pump, actual speed	Flue gas temperature	Burner	Burner starts	Burner hours run	Thermal output	Central fault message	Screed drying prog.	Diverter valve	Time	Date	Boiler serial number	Device serial number		Burner		<table border="1"> <tr><td>Burner</td></tr> <tr><td>Burner hours run</td></tr> <tr><td>Burner starts</td></tr> <tr><td>Burner modulation</td></tr> <tr><td>Flow temperature</td></tr> <tr><td>Flue gas temperature</td></tr> <tr><td>Flow sensor</td></tr> </table>	Burner	Burner hours run	Burner starts	Burner modulation	Flow temperature	Flue gas temperature	Flow sensor
	General																																
	<table border="1"> <tr><td>System pressure</td></tr> <tr><td>Outside temperature</td></tr> <tr><td>Flow temperature</td></tr> <tr><td>Primary circuit pump, set speed</td></tr> <tr><td>Primary circuit pump, actual speed</td></tr> <tr><td>Flue gas temperature</td></tr> <tr><td>Burner</td></tr> <tr><td>Burner starts</td></tr> <tr><td>Burner hours run</td></tr> <tr><td>Thermal output</td></tr> <tr><td>Central fault message</td></tr> <tr><td>Screed drying prog.</td></tr> <tr><td>Diverter valve</td></tr> <tr><td>Time</td></tr> <tr><td>Date</td></tr> <tr><td>Boiler serial number</td></tr> <tr><td>Device serial number</td></tr> </table>	System pressure	Outside temperature	Flow temperature	Primary circuit pump, set speed	Primary circuit pump, actual speed	Flue gas temperature	Burner	Burner starts	Burner hours run	Thermal output	Central fault message	Screed drying prog.	Diverter valve	Time	Date	Boiler serial number	Device serial number															
System pressure																																	
Outside temperature																																	
Flow temperature																																	
Primary circuit pump, set speed																																	
Primary circuit pump, actual speed																																	
Flue gas temperature																																	
Burner																																	
Burner starts																																	
Burner hours run																																	
Thermal output																																	
Central fault message																																	
Screed drying prog.																																	
Diverter valve																																	
Time																																	
Date																																	
Boiler serial number																																	
Device serial number																																	
	Burner																																
	<table border="1"> <tr><td>Burner</td></tr> <tr><td>Burner hours run</td></tr> <tr><td>Burner starts</td></tr> <tr><td>Burner modulation</td></tr> <tr><td>Flow temperature</td></tr> <tr><td>Flue gas temperature</td></tr> <tr><td>Flow sensor</td></tr> </table>	Burner	Burner hours run	Burner starts	Burner modulation	Flow temperature	Flue gas temperature	Flow sensor																									
Burner																																	
Burner hours run																																	
Burner starts																																	
Burner modulation																																	
Flow temperature																																	
Flue gas temperature																																	
Flow sensor																																	

## Overview of main menu (cont.)

## Information

## Heating circuit 1

Operating program

Operating status

Room temperature

Set room temperature

Reduced

Standard

Only for weather-compensated or continuous operation:  
ComfortOnly for weather-compensated operation:  
SlopeOnly for weather-compensated operation:  
Level

Heating circuit pump

Flow temperature

Set flow temperature

Only for weather-compensated or continuous operation:  
HolidayOnly for weather-compensated or continuous operation:  
Day(s) at homeOnly for weather-compensated or continuous operation:  
Additional heating circuits

As for Heating circuit 1

## DHW

DHW temperature

Set temperature

DHW circulation pump

Cylinder loading pump

## Solar

Collector temperature

Solar DHW

Hours run, solar circuit pump

Current solar yield in kWh

Solar circuit pump On/Off

Reheating suppression in °C or °F

Solar stagnation in h

TS3: Buffer temperature

TS4: Return temperature, heating circuit

Solar circulation pump speed

TS3: DHW preheating

TS4: DHW reheating

Solar 3-way valve position



## Overview of main menu (cont.)

Information																																									
	<table border="1"> <tr> <td colspan="2">COMM. MODULE</td> </tr> <tr> <td></td> <td> <table border="1"> <tr> <td colspan="2">COMM. MODULE</td> </tr> <tr> <td></td> <td> <table border="1"> <tr> <td>Manufacturer's details</td> </tr> <tr> <td>Software version</td> </tr> </table> </td> </tr> <tr> <td>WiFi</td> <td> <table border="1"> <tr> <td>MAC address</td> </tr> <tr> <td>Activated</td> </tr> <tr> <td>Network</td> </tr> <tr> <td>Signal strength</td> </tr> <tr> <td>DHCP activated</td> </tr> <tr> <td>Ipv4 address</td> </tr> <tr> <td>Ipv4 subnet mask</td> </tr> <tr> <td>Standard gateway</td> </tr> <tr> <td>Primary DNS server</td> </tr> <tr> <td>Secondary DNS server</td> </tr> <tr> <td>Backend connection</td> </tr> <tr> <td>Network connection</td> </tr> </table> </td> </tr> <tr> <td>More</td> <td> <table border="1"> <tr> <td>EUI-64</td> </tr> <tr> <td>IC</td> </tr> </table> </td> </tr> </table> </td> </tr> <tr> <td></td> <td>System information</td> </tr> <tr> <td></td> <td> <table border="1"> <tr> <td>Active messages</td> </tr> <tr> <td>Message history</td> </tr> </table> </td> </tr> <tr> <td></td> <td>Contractor</td> </tr> <tr> <td></td> <td></td> </tr> <tr> <td></td> <td>Open source license</td> </tr> </table>	COMM. MODULE			<table border="1"> <tr> <td colspan="2">COMM. MODULE</td> </tr> <tr> <td></td> <td> <table border="1"> <tr> <td>Manufacturer's details</td> </tr> <tr> <td>Software version</td> </tr> </table> </td> </tr> <tr> <td>WiFi</td> <td> <table border="1"> <tr> <td>MAC address</td> </tr> <tr> <td>Activated</td> </tr> <tr> <td>Network</td> </tr> <tr> <td>Signal strength</td> </tr> <tr> <td>DHCP activated</td> </tr> <tr> <td>Ipv4 address</td> </tr> <tr> <td>Ipv4 subnet mask</td> </tr> <tr> <td>Standard gateway</td> </tr> <tr> <td>Primary DNS server</td> </tr> <tr> <td>Secondary DNS server</td> </tr> <tr> <td>Backend connection</td> </tr> <tr> <td>Network connection</td> </tr> </table> </td> </tr> <tr> <td>More</td> <td> <table border="1"> <tr> <td>EUI-64</td> </tr> <tr> <td>IC</td> </tr> </table> </td> </tr> </table>	COMM. MODULE			<table border="1"> <tr> <td>Manufacturer's details</td> </tr> <tr> <td>Software version</td> </tr> </table>	Manufacturer's details	Software version	WiFi	<table border="1"> <tr> <td>MAC address</td> </tr> <tr> <td>Activated</td> </tr> <tr> <td>Network</td> </tr> <tr> <td>Signal strength</td> </tr> <tr> <td>DHCP activated</td> </tr> <tr> <td>Ipv4 address</td> </tr> <tr> <td>Ipv4 subnet mask</td> </tr> <tr> <td>Standard gateway</td> </tr> <tr> <td>Primary DNS server</td> </tr> <tr> <td>Secondary DNS server</td> </tr> <tr> <td>Backend connection</td> </tr> <tr> <td>Network connection</td> </tr> </table>	MAC address	Activated	Network	Signal strength	DHCP activated	Ipv4 address	Ipv4 subnet mask	Standard gateway	Primary DNS server	Secondary DNS server	Backend connection	Network connection	More	<table border="1"> <tr> <td>EUI-64</td> </tr> <tr> <td>IC</td> </tr> </table>	EUI-64	IC		System information		<table border="1"> <tr> <td>Active messages</td> </tr> <tr> <td>Message history</td> </tr> </table>	Active messages	Message history		Contractor				Open source license
COMM. MODULE																																									
	<table border="1"> <tr> <td colspan="2">COMM. MODULE</td> </tr> <tr> <td></td> <td> <table border="1"> <tr> <td>Manufacturer's details</td> </tr> <tr> <td>Software version</td> </tr> </table> </td> </tr> <tr> <td>WiFi</td> <td> <table border="1"> <tr> <td>MAC address</td> </tr> <tr> <td>Activated</td> </tr> <tr> <td>Network</td> </tr> <tr> <td>Signal strength</td> </tr> <tr> <td>DHCP activated</td> </tr> <tr> <td>Ipv4 address</td> </tr> <tr> <td>Ipv4 subnet mask</td> </tr> <tr> <td>Standard gateway</td> </tr> <tr> <td>Primary DNS server</td> </tr> <tr> <td>Secondary DNS server</td> </tr> <tr> <td>Backend connection</td> </tr> <tr> <td>Network connection</td> </tr> </table> </td> </tr> <tr> <td>More</td> <td> <table border="1"> <tr> <td>EUI-64</td> </tr> <tr> <td>IC</td> </tr> </table> </td> </tr> </table>	COMM. MODULE			<table border="1"> <tr> <td>Manufacturer's details</td> </tr> <tr> <td>Software version</td> </tr> </table>	Manufacturer's details	Software version	WiFi	<table border="1"> <tr> <td>MAC address</td> </tr> <tr> <td>Activated</td> </tr> <tr> <td>Network</td> </tr> <tr> <td>Signal strength</td> </tr> <tr> <td>DHCP activated</td> </tr> <tr> <td>Ipv4 address</td> </tr> <tr> <td>Ipv4 subnet mask</td> </tr> <tr> <td>Standard gateway</td> </tr> <tr> <td>Primary DNS server</td> </tr> <tr> <td>Secondary DNS server</td> </tr> <tr> <td>Backend connection</td> </tr> <tr> <td>Network connection</td> </tr> </table>	MAC address	Activated	Network	Signal strength	DHCP activated	Ipv4 address	Ipv4 subnet mask	Standard gateway	Primary DNS server	Secondary DNS server	Backend connection	Network connection	More	<table border="1"> <tr> <td>EUI-64</td> </tr> <tr> <td>IC</td> </tr> </table>	EUI-64	IC																
COMM. MODULE																																									
	<table border="1"> <tr> <td>Manufacturer's details</td> </tr> <tr> <td>Software version</td> </tr> </table>	Manufacturer's details	Software version																																						
Manufacturer's details																																									
Software version																																									
WiFi	<table border="1"> <tr> <td>MAC address</td> </tr> <tr> <td>Activated</td> </tr> <tr> <td>Network</td> </tr> <tr> <td>Signal strength</td> </tr> <tr> <td>DHCP activated</td> </tr> <tr> <td>Ipv4 address</td> </tr> <tr> <td>Ipv4 subnet mask</td> </tr> <tr> <td>Standard gateway</td> </tr> <tr> <td>Primary DNS server</td> </tr> <tr> <td>Secondary DNS server</td> </tr> <tr> <td>Backend connection</td> </tr> <tr> <td>Network connection</td> </tr> </table>	MAC address	Activated	Network	Signal strength	DHCP activated	Ipv4 address	Ipv4 subnet mask	Standard gateway	Primary DNS server	Secondary DNS server	Backend connection	Network connection																												
MAC address																																									
Activated																																									
Network																																									
Signal strength																																									
DHCP activated																																									
Ipv4 address																																									
Ipv4 subnet mask																																									
Standard gateway																																									
Primary DNS server																																									
Secondary DNS server																																									
Backend connection																																									
Network connection																																									
More	<table border="1"> <tr> <td>EUI-64</td> </tr> <tr> <td>IC</td> </tr> </table>	EUI-64	IC																																						
EUI-64																																									
IC																																									
	System information																																								
	<table border="1"> <tr> <td>Active messages</td> </tr> <tr> <td>Message history</td> </tr> </table>	Active messages	Message history																																						
Active messages																																									
Message history																																									
	Contractor																																								
	Open source license																																								

## Overview of main menu (cont.)

### Settings

Only for weather-compensated operation: Heating curve	
	Heating circuit 1
	Additional heating circuits
Date and time	
	Date
	Time
Display brightness	
	Display
	Lightguide
Language	
Low power radio	
Units	
	Temperature/length
	Pressure
Factory settings	

### Test mode

## Terminology

### Standby mode

Heat generation is switched off.

#### Note

*Standby mode can be selectively enabled for one or more heating circuits or for DHW heating.*

If all heating circuits and DHW heating are shut down: Frost protection is only active for the heat generator and DHW cylinder. No central heating, no DHW heating.

### Setback mode (reduced heating mode)

See "Reduced heating mode".

### System version

The system version describes the components of your system.

Some examples:

- Heat generator
- Heating circuit pump
- Mixer

- Valves
- Electronics module
- Radiator

Every system is individually configured and adapted to the local conditions by your heating contractor.

## Terminology (cont.)

### Operating program

The operating program enables you to define the following, for example:

- How you heat your rooms
- Whether you heat DHW

---

### Operating status

See "Time program".

---

### Operating mode

See "Heating operation".

---

### Mixer extension kit

Assembly (accessories) for controlling a heating circuit with mixer: See "Mixer".

---

### Screed drying

Your contractor can switch on this function for screed drying, for example in your new build or extension. This means your screed is dried in line with a fixed time program (temperature/time profile) that is appropriate for the building materials used.

Screed drying affects all heating circuits:

- All rooms are heated according to the temperature/time profile.  
Your settings for central heating have no effect on the duration of screed drying (max. 32 days).
- No DHW heating

---

### Underfloor heating

Underfloor heating systems are slow, low temperature heating systems that respond only very slowly to short term temperature changes.

Heating with reduced room temperature at night therefore does not result in any significant energy savings.

---

### Heating mode

#### Operating modes

To heat your home, the heat generator provides heat as specified by the set flow temperature. The operating mode determines whether the flow temperature is specified with a fixed value or whether it is automatically calculated and adjusted subject to several ancillary conditions.

Your contractor can configure the following operating modes during commissioning:

- Weather-compensated operation
- Continuous operation
- Room temperature-dependent operation

#### Comfort mode

For periods when you are at home during the day, heat your home with the comfort room temperature or the comfort flow temperature, depending on the operating mode. Set the periods (time phases) with the "**Comfort**" temperature level using the time program for central heating.

#### Continuous operation

In continuous operation the heat generator provides heating water with a constant flow temperature regardless of the outside temperature.

With this operating mode, you can operate several heating circuits via your control unit.

## Terminology (cont.)

### Standard heating mode

For periods when you are at home during the day, heat your home with the normal room temperature or the normal flow temperature, depending on the operating mode. Set the periods (time phases) with the **"Standard"** temperature level using the time program for central heating.

### Room temperature-dependent heating operation

In room temperature-dependent operation a room is heated until the set room temperature has been reached. For this, a separate temperature sensor must be installed in the room.

The heating output is controlled independently of the outside temperature.

With this operating mode, you can operate one heating circuit via your control unit. You can input some of the settings for this heating circuit at your room temperature controller.

### Reduced heating operation

For periods when you will be absent or during the night, heat your rooms with the reduced room temperature or the reduced flow temperature, depending on the operating mode. Set the periods (time phases) with the **"Reduced"** temperature level using the time program for central heating.

With underfloor heating systems, reduced heating operation only yields limited energy savings (see "Underfloor heating system").

### Weather-compensated heating operation

In weather-compensated operation, the flow temperature is controlled according to the outside temperature. More heat is made available at a lower outside temperature than at a higher one.

The outside temperature is captured and transmitted to the control unit by a sensor fitted outside the building. With this operating mode, you can operate several heating circuits via your control unit. If remote control units are installed in your rooms, you can also adjust the settings at the remote control units.

## Heating curve

Heating curves illustrate the relationship between the outside temperature, the set room temperature and the flow temperature. The lower the outside temperature, the higher the flow temperature.

In order to guarantee sufficient heat with minimum energy consumption at any outside temperature, the conditions of your building and system must be taken into consideration. The heating curve is adjusted by your contractor for this purpose.

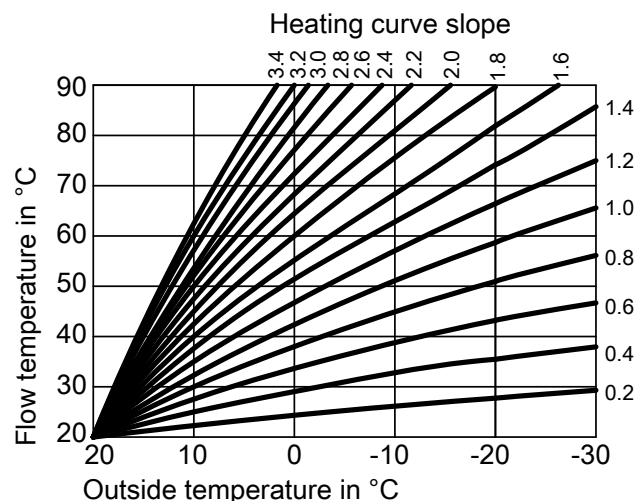

Fig. 6

### Setting the slope and level, taking the heating curve as an example

Factory settings:

- Slope = 1.4
- Level = 0

The heating curves shown apply with the following settings:

- Heating curve level = 0
- Standard room temperature (set room temperature) = 20 °C

## Terminology (cont.)

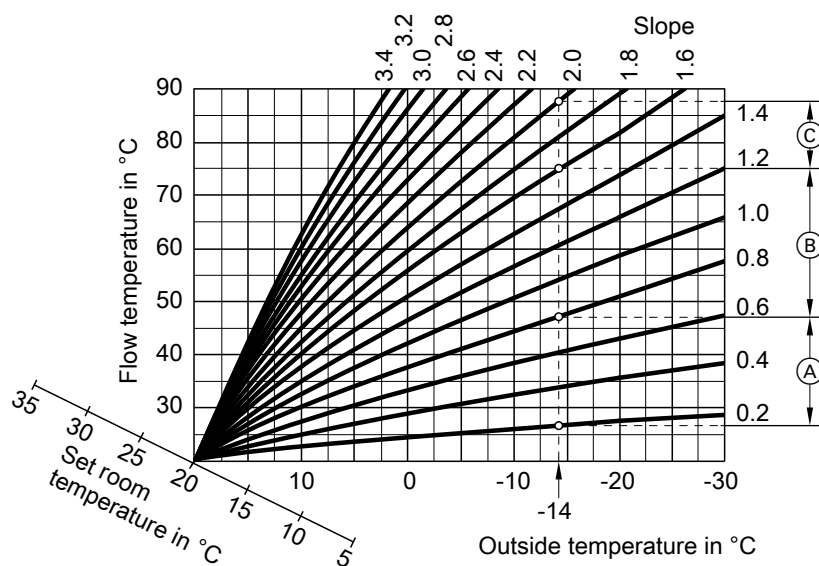

Fig. 7

For an outside temperature of  $-14\text{ }^{\circ}\text{C}$ :

- (A) Underfloor heating system: Slope 0.2 to 0.8
- (B) Low temperature heating system: Slope 0.8 to 1.6
- (C) System with a flow temperature in excess of  $75\text{ }^{\circ}\text{C}$ , slope 1.6 to 2.0

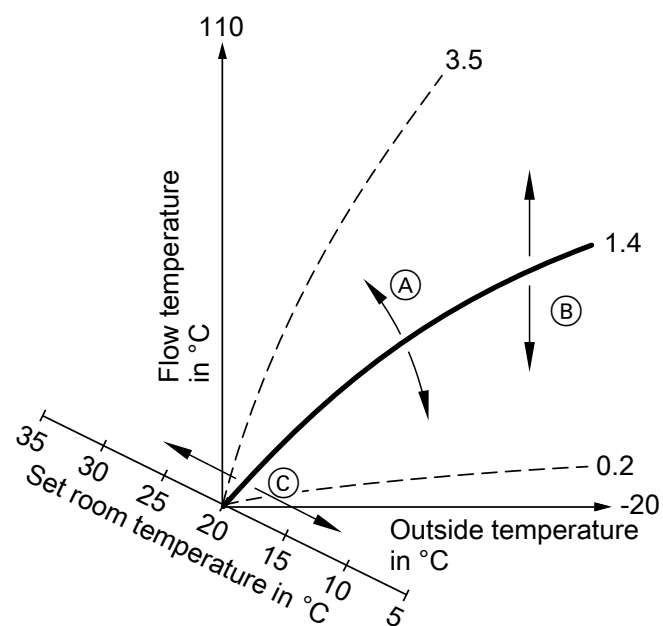

Fig. 8

- (A) If you change the slope:  
The steepness of the heating curves changes.
- (B) If you change the level:  
The heating curves are shifted in parallel in a vertical direction.
- (C) If you change the standard room temperature (set room temperature):  
The heating curves are shifted along the "Set room temperature" axis.

**Note**

Setting the slope or level too high or too low will not cause any damage to your heating system. Both settings affect the level of the flow temperature, which may then be too low or unnecessarily high.

#### Heating circuit

A heating circuit is a sealed unvented circuit connecting the heat generator and the radiators, in which the heating water circulates.

A system may comprise several heating circuits. For example, one heating circuit for the rooms occupied by you and one heating circuit for the rooms of a separate apartment.

The heating circuits are designated at the factory as **"Heating circuit 1"**, **"Heating circuit 2"**, etc.

If you or your qualified contractor have renamed the heating circuits, e.g. as "Apartment", that name will be displayed instead of **"Heating circuit..."**.

---

#### Heating circuit pump

Circulation pump for circulating the heating water in the heating circuit

---

#### Mixer

Hot heating water from the heat generator is mixed with cooled heating water from the heating circuit. The heating water, thus brought to the required temperature, is pumped to the heating circuit by the heating circuit pump. To ensure the required set room temperature is achieved, the control unit adjusts the flow temperature via the mixer to suit different conditions.

---

#### Night setback

See "Reduced heating mode"

---

#### Open flue operation

The combustion air is drawn from the room where the heat generator is installed.

---

#### Room sealed operation

The combustion air is drawn from outside the building.

---

#### Room temperature

- Standard room temperature or comfort room temperature:  
Set the standard room temperature or comfort room temperature for periods when you are at home during the day.
- Reduced room temperature:  
For periods when you will be absent or during the night, set the reduced room temperature; see "Heating mode".

---

#### Return temperature

The return temperature is the temperature at which the heating water leaves a system component such as a heating circuit.

## Terminology (cont.)

### Safety valve

Safety equipment that must be installed in the cold water pipe by your contractor. The safety valve opens automatically to prevent excess pressure in the DHW cylinder.

The heating circuits are also equipped with safety valves.

---

### Solar circuit pump

In conjunction with solar thermal systems.

The solar circuit pump delivers the cooled heat transfer medium from the indirect coil of the DHW cylinder to the solar collectors.

---

### Set temperature

See "Set temperature".

---

### Summer mode

In warmer months, you can switch off heating operation.

To do so, set the **"DHW"** operating program to **"On"** and the **"Heating circuit"** to **"Off"**.

The system remains in operation for DHW heating. Central heating is switched off.

---

### Cylinder primary pump

Circulation pump for heating the DHW in the DHW cylinder.

---

### Temperature level

You can specify set values for 3 different temperature levels:

- **"Standard"**
- **"Reduced"**
- **"Comfort"**

---

### Set temperature

Specific temperature that should be reached, e.g. set DHW temperature for example.

---

### Drinking water filter

A device that removes solids from the drinking water. The drinking water filter is built into the cold water pipework to the DHW cylinder.

---

### Flow temperature

The flow temperature is the temperature at which the heating water enters a system component such as a heating circuit.

### Terminology (cont.)

#### Weather-compensated operation

See "Heating mode"

---

#### Time program

In the time programs, you specify what your heating system should do at what time.

For example, the operating statuses for central heating have different temperature levels.

The times for the operating status changeover are defined when the time programs are set.

#### Operating status

The operating status indicates how a component of your heating system is being operated.

---

#### DHW circulation pump

The DHW circulation pump transports the DHW around a loop line between the DHW cylinder and the draw-off points (e.g. hot tap). This ensures that hot water is rapidly available at the draw-off points.

---

### Information on disposal

#### Disposal of packaging

Your contractor will dispose of the packaging from your Viessmann product.

---

#### Final decommissioning and disposal of the heating system

Viessmann products can be recycled. Components and fluids from your heating system do not belong in ordinary domestic waste. Please speak to your contractor about the correct disposal of your old system.



**Keyword index**

<b>A</b>	
Actual temperature, checking.....	37
Ambient temperatures.....	11
<b>B</b>	
Brightness setting.....	32
Burner reset.....	41
<b>C</b>	
Central heating	
– Factory settings.....	12
– Operating program.....	17
Central heating, switching on/off.....	23
Check	
– Fault message.....	40
– Help messages.....	37
– Information.....	37
– Operating statuses.....	37
– Service message (maintenance message).....	39
– Temperatures.....	37
Cleaning.....	50
Cleaning information.....	50
Cold rooms.....	47
Comfort (tips).....	13
Commissioning.....	12, 45
Controls.....	15
Cylinder primary pump.....	63
<b>D</b>	
Date/time, factory setting.....	12
Date setting.....	32
Day(s) at home, changing.....	26
Day(s) at home, switching off.....	27
Day(s) at home, switching on.....	26
Day temperature (standard flow temperature).....	12
Day temperature (standard room temperature).....	12, 23
Default setting.....	12
DHW circulation pump.....	64
– Energy saving.....	13
– Time phases.....	22
– Time program.....	22
DHW comfort function	
– Time phases.....	22
– Time program.....	22
DHW heating	
– Comfort.....	14
– Energy saving.....	13
– Factory setting.....	12
– Operating program.....	17, 29
– Outside time program.....	29
DHW hygiene.....	30
DHW temperature, setting.....	29
Display backlight.....	32
Drinking water filter.....	63
<b>E</b>	
Emissions test mode.....	43
Energy saving (tips).....	13
Energy saving function	
– Holiday program.....	27
– In long periods of absence.....	27
Extension kit.....	59
External hook-up.....	18
<b>F</b>	
Factory setting.....	12
Factory settings reset.....	36
Fault display.....	49
Fault message	
– Acknowledging.....	40
– Checking.....	40
Filter (drinking water).....	63
Flow temperature.....	23, 63
Flue gas emissions testing.....	43
Frost protection.....	12
Frost protection monitoring.....	12, 44
Further settings.....	32
<b>G</b>	
Glossary.....	58
<b>H</b>	
Heat generator, switching on.....	45
Heat generator heating characteristics, changing.....	24
Heating circuit.....	62
Heating circuit pump.....	62
Heating circuit with mixer.....	59
Heating curve	
– Explanation.....	60
Heating curve, setting.....	24
Heating times setting.....	19
Help messages, calling up.....	37
Higher DHW temperature.....	30
Holiday.....	27
– Changing.....	28
– Switching off.....	28
– Switching on.....	27
Holiday at home.....	13
Holiday program, switching on.....	27
Home screen	
– Calling up.....	15
<b>I</b>	
Information.....	11
Information, checking.....	37
Inspection.....	50
Installation room.....	11
Internet access, switching on.....	35
<b>L</b>	
Language selection.....	34
Legal information	
– Programming unit.....	38
– Wireless module.....	38
Level.....	24
Level of heating curve.....	60
Liability.....	9

**Keyword index** (cont.)

Licences.....	11	Room sealed operation.....	62
– Wireless module.....	38	Room temperature.....	23
Licenses		– Adjusting for longer periods at home.....	25
– Programming unit.....	38	– Energy saving.....	13
Lightguide.....	15, 32	<b>S</b>	
– Meaning.....	15	Safety valve.....	63
Low power radio On/Off.....	35	Screed drying.....	18
<b>M</b>		Screensaver.....	15
Main menu.....	16	Service contract.....	50
Maintenance.....	50	Service message	
Menu structure.....	52, 53	– Display.....	49
<b>N</b>		Service message, checking.....	39
Night setback.....	62	Setback mode.....	58
Night temperature (reduced flow temperature).....	12	Set temperature.....	63
Night temperature (reduced room temperature).....	12	Shutdown.....	44
No hot water.....	48	Slope.....	24
Notice of completion.....	12	Slope of heating curve.....	60
Notification of completion.....	12	Solar thermal system.....	63
<b>O</b>		Standard flow temperature (day temperature).....	12
ON/OFF switch .....	45	Standard heating operation.....	12
One-off DHW heating		Standard room temperature (day temperature).....	12
– Switching off.....	30	Standard settings.....	36
– Switching on.....	29	Standby.....	15
On-screen buttons.....	16	Standby mode.....	58, 59
Open flue operation.....	62	Status display.....	15
Open source licences		Summer mode.....	59, 63
– Programming unit.....	38	Summertime changeover.....	12
– Wireless module.....	38	Summertime setting.....	34
Operating levels.....	16	Switching off	
Operating mode		– Heating system with frost protection monitoring.....	44
– Explanation.....	59	– System without frost protection monitoring.....	44
Operating program.....	18, 29	Switching on.....	45
– Central heating, DHW.....	17	– Frost protection monitoring.....	44
– DHW only.....	63	– Standby mode.....	44
– Terminology.....	59	Symbols.....	10
Operating status.....	64	System, switching on.....	45
– Explanation.....	59	System overview.....	16
Operating statuses, checking.....	37	<b>T</b>	
<b>P</b>		Temperature.....	23
Power failure.....	12	– Set temperature.....	63
Pressure gauge.....	45	Temperature, checking.....	37
Pressure indicator.....	45	Temperature level.....	63
Product information.....	11	Terminology.....	58
Pump		Test mode.....	43
– Cylinder heating.....	63	Time/date, factory setting.....	12
– DHW circulation.....	64	Time phase changing.....	21
– Heating circuit.....	62	Time phase deletion.....	21
– Solar circuit.....	63	Time phases	
<b>R</b>		– DHW circulation pump.....	22
Reduced flow temperature (night temperature).....	12	– DHW comfort function.....	22
Reduced heating operation.....	12	Time phase setting.....	19
Reduced room temperature (night temperature).....	12	Time program.....	13, 64
Reset.....	36	– Comfort.....	13
Return temperature.....	62	– DHW circulation pump.....	22
		– DHW comfort function.....	22
		– Energy saving.....	13
		Time program, setting.....	19
		Time programs.....	19

**Keyword index** (cont.)

Time setting.....	32	Weather-compensated operation.....	64
Troubleshooting.....	47	WiFi.....	35
<b>U</b>		WiFi connection.....	35, 36
Underfloor heating.....	59	WiFi network.....	36
Units, setting.....	34	Winter mode.....	59
Utilisation.....	10	Wintertime/summertime changeover.....	12
<b>W</b>		Wintertime changeover.....	12
Water too cold.....	48	Wintertime setting.....	34
Water too hot.....	49	Wireless remote control connection, switching on.....	35

## Certification

**RoHS**  
compliant  
2011 / 65 / EU

## Your contact

Contact your local contractor if you have any questions about your system or wish to arrange maintenance or repair work. You can find local contractors on the internet at [www.viessmann.de](http://www.viessmann.de).



Viessmann Climate Solutions SE  
35108 Allendorf / Germany  
Telephone: +49 6452 70-0  
Fax: +49 6452 70-2780  
[www.viessmann.com](http://www.viessmann.com)

Viessmann Limited  
Hortonwood 30, Telford  
Shropshire, TF1 7YP, GB  
Telephone: +44 1952 675000  
Fax: +44 1952 675040  
E-mail: [info-uk@viessmann.com](mailto:info-uk@viessmann.com)

5593241 Subject to technical modifications.